

Avery Weigh-Tronix

User Manual

Model: ZM 110

BSL Bench Scale



Avery Weigh-Tronix is a trademark of the Illinois Tool Works group of companies whose ultimate parent company is Illinois Tool Works Inc (“Illinois Tool Works”). Copyright © 2024 Illinois Tool Works. All rights reserved.

No part of this publication may be reproduced, stored in an electronic retrieval system, or transmitted in any form or by any means, electronic, mechanical, photocopying, recording or otherwise without the prior written consent of the copyright owner, or as permitted by law or under license. Full acknowledgment of the source must be given.

Avery Weigh-Tronix is a registered trade mark of the Avery Weigh-Tronix group of companies. This publication was correct at the time of going to print however, Avery Weigh-Tronix reserves the right to alter without notice the specification, design, price or conditions of supply of any product or service at any time.

All third party brands and product names used within this document are trademarks or registered trademarks of their respective holders.

© Groupe de sociétés Avery Weigh-Tronix, 2024. Tous droits réservés.

Aucune partie de cette publication ne peut être reproduite, enregistrée dans un système de récupération électronique ou transmise sous quelque forme ou par quelque moyen que ce soit, électronique ou mécanique, par photocopie, enregistrement ou autre, sans l'accord écrit préalable du propriétaire du droit d'auteur ou tel qu'autorisé par la loi ou dans le cadre d'une licence. La source doit être reconnue dans son intégralité. Avery Weigh-Tronix est une marque déposée du groupe de sociétés Avery Weigh-Tronix. Le contenu de cette publication était correct au moment de sa mise sous presse. Toutefois, Avery Weigh-Tronix se réserve le droit de modifier à tout moment et sans préavis les spécifications, la conception, les tarifs ou les conditions d'approvisionnement de tout produit ou service.

Toutes les marques et tous les noms de produits tiers utilisés dans ce document sont des marques de commerce ou des marques déposées de leurs propriétaires respectifs.

Table of Contents

1. General information and Warnings page 6

FCC Declaration of Compliance - <i>Déclaration de conformité</i>	6
Training - <i>Formation</i>	7
Battery Safe Disposal - <i>Élimination sécurisée des batteries</i>	7
Routine Maintenance - <i>Entretien de routine</i>	7
Cleaning the Machine - <i>Nettoyage de la machine</i>	7
Sharp Objects - <i>Objets tranchants</i>	7

2. Introduction page 8

Unpacking.....	8
General Installation Guidelines.....	8
Levelling the Scale.....	8
Scale Installation.....	9
Battery Operation.....	10
Powering UP/DOWN the Scale.....	10
Front Panel.....	10
Display Annunciators.....	10
Operation Keys.....	11
Error Codes.....	11

3. Scale Operation page 12

Gross Weighing.....	12
Tare Weighing.....	12
Clear a Tare.....	12
Counting Mode.....	12
Sampling Parts Prior to Counting.....	13
Check Counting.....	13
Checkweighing Mode.....	13
Setting the Checkweighing Limits.....	14

Checkweighing Beeper Modes.....	14
Hold Mode for Animal Weighing.....	15
Setting the Hold Mode.....	16
4. Menus	page 17
User Menu.....	17
User Menu Levels.....	17
User Functions Descriptions [UF].....	18
Supervisor Menu.....	19
Quick Calibration Menu.....	19
5. Scale Configuration [LF 2]	page 19
6. RS232 Communications [UF-6]	page 19
7. Replacement Parts	page 20
8. Loadcell Pinouts	page 20

Manual revision history

Current Issue	Date Created	Details of Changes
AA	May 2019	New
AB	Aug 2019	RS232 Kit added and Chapter 6 amended
AC	Jan 2020	Check Counting, UF5 amended
AD	Feb 2023	Hold Mode, UF5 updated
AE AE.1	January 2024 December 2024	Error Codes, updated



1. General Information and Warnings

1.1. FCC Declarations of Compliance - FCC Déclaration de conformité

United States

This equipment has been tested and found to comply with the limits for a Class A digital device, pursuant to Part 15 of the FCC Rules. These limits are designed to provide reasonable protection against harmful interference when the equipment is operated in a commercial environment. This equipment generates, uses, and can radiate radio frequency energy and, if not installed and used in accordance with the instruction manual, may cause harmful interference to radio communications. Operation of this equipment in a residential area is likely to cause harmful interference in which case the user will be required to correct the interference at his own expense.

Canada

This digital apparatus does not exceed the Class A limits for radio noise emissions from digital apparatus set out in the Radio Interference Regulations of the Canadian Department of Communications.

Le présent appareil numérique n'émet pas de bruits radioélectriques dépassant les limites applicables aux appareils numériques de la Classe A prescrites dans le Règlement sur le brouillage radioélectrique édicté par le ministère des Communications du Canada. Interference Regulations of the Canadian Department of Communications.

1.2. Training - Formation

Do not attempt to operate or complete any procedure on a machine unless you have received the appropriate training or read the instruction books.

Ne pas tenter d'utiliser la machine ou lui appliquer une quelconque procédure sans avoir reçu une formation adaptée ou lu les manuels d'instruction.



CAUTION! Risk of electrical shock. Refer to qualified service personnel for service.

ATTENTION! Risque de choc électrique. Confier la réparation de l'appareil à un personnel qualifié.

1.3. Safe Battery Disposal - Élimination sécurisée des batteries

Please be aware this product contains a lead acid battery which MUST be removed and disposed of safely prior to any disposal of the scale.

This battery can be easily accessed by removing the battery cover found on the underside of the indicator.



CAUTION! Danger of explosion if battery is incorrectly replaced. Replace only with the same or equivalent type recommended by the manufacturer.

ATTENTION! Il y a danger d'explosion s'il y a remplacement incorrect de la batterie, remplacer uniquement avec une batterie du même type ou d'un type équivalent recommandé par le constructeur.

1.4. Routine Maintenance - Entretien de routine

IMPORTANT: This equipment must be routinely checked for proper operation and calibration. Application and usage will determine the frequency of calibration required for safe operation.

PRUDENCE: Le fonctionnement et l'étalonnage de cet équipement doivent être vérifiés régulièrement. Les applications et l'utilisation déterminent la fréquence de l'étalonnage requis pour une utilisation en toute sécurité.

1.5. Cleaning of Scale - Nettoyage de la machine

Do - Ce qu'il faut faire	Do NOT - Ce qu'il ne faut pas faire
Wipe down the outside of product with a clean cloth, moistened with water and a small amount of mild detergent cleaning fluid. <i>Essuyer la partie externe des produits standard à l'aide d'un chiffon propre légèrement imprégné d'eau et d'une petite quantité de détergent doux.</i>	Use harsh abrasives, solvents, scouring cleaners or alkaline cleaning solutions. <i>Utiliser des produits abrasifs, des solvants, des produits de récurage ou des solutions de nettoyage alcalines.</i>
Spray on to the cloth when cleaning and not directly onto the indicator area. <i>Pulvériser tout produit de nettoyage spécifique sur le chiffon.</i>	Do not attempt to clean the inside of the machine. <i>Tenter de nettoyer l'intérieur de la machine.</i>
	Spray any liquid directly on to the display windows. <i>Pulvériser des liquides directement sur les écrans d'affichage.</i>

1.6. Sharp Objects - Objets tranchants

Do not use any sharp objects such as screwdrivers or long fingernails to operate the keys.

Ne pas appuyer sur les touches avec des objets tranchants tels que des tournevis ou même des ongles longs.

2. Introduction

The ZM110 is a general-purpose indicator ideal for connecting to most bench and floor scales. This indicator can easily be desk or pole mounted and comes with a power adaptor along with a rechargeable lead acid battery to allow the scale to be used in applications where power outlets are limited.

This ZM110 indicator comes standard with a range of easy-to-operate General weighing functions along with basic Check weighing, Counting and Hold modes.

2.1 Unpacking

Carefully take the scale out of its package, make sure it's not damaged and all accessories are included.

- Remove the scale from the carton;
- Remove the protective covering;
- Inspect the scale and indicator for damage;
- Make sure all components are included:
 1. ZM110 Indicator
 2. Adaptor plus plug adaptors
 3. BSL Platform, column and brackets
 4. Product manual

2.2. General Installation Guidelines

To get the best performance from the scale try to place the ZM110 in a location that will not degrade its accuracy.

- Avoid extremes of temperature. Try to avoid placing the scale in direct sunlight or near air vents;
- Place the scale on a level flat surface. It is not advised to place the scale near vibrating machinery;
- Avoid unstable power sources. Do not use near large users of electricity e.g. welding equipment.

2.2.1 Levelling the Scale

Level the scale using the four adjustable feet on the bottom of the scale, Figure 1, and the bubble level near the base of the column, Figure 2.

 **Always check the level prior to using scale.**

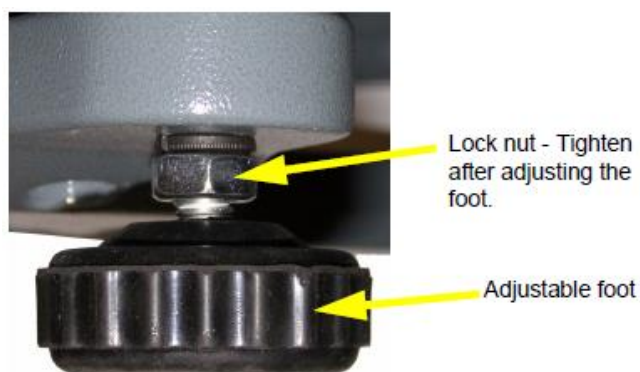

Fig. 1 Adjust scale feet to level the scale



Fig. 2 Adjust feet until bubble is centered in black circle

2.2.2 Scale Installation

1. Attach the support column to the bracket at the back of the scale base using the three mounting screws. Use a 3mm hex (Allen) key to tighten the screws. See Figure 3.

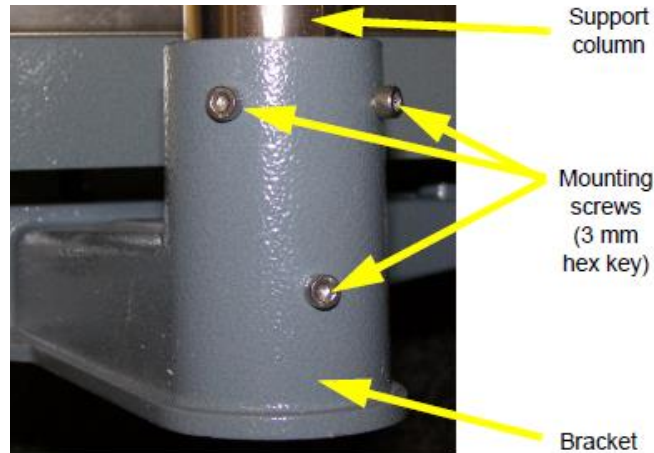

Fig. 3 Insert column into bracket and secure with three screws

2. Place the indicator on the top bracket as shown in Figure 4 and slide it down until it snaps into the final position. Loosen the adjustment knob shown in Figure 4 and adjust the indicator's angle for best viewing of the display, then tighten the knob.



Fig. 4 Slide indicator head onto column bracket

3. The cable from the base to the indicator is run through the column and out through the plastic bracket at the top when you unpack the scale. Make sure the connector is free of obstructions, i.e. packing foam, and plug the cable into the connector, as shown in Figure 5. Tighten the threaded collar.
4. Attach the AC power adapter to the connector on the back of the indicator. See Figure 5.

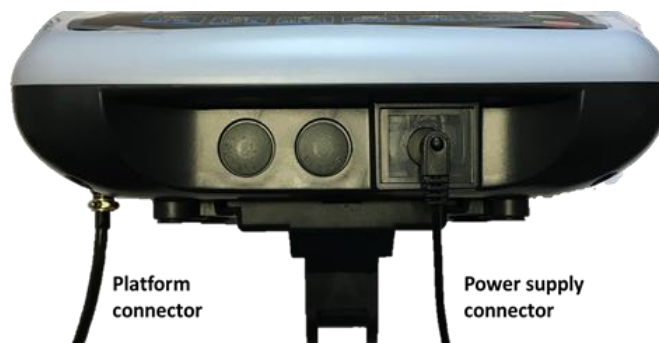



Fig. 5 Signal cable plugged into back of the indicator

2.3. Battery Operation

The ZM 110 can be operated from a 6V 4Ahrs battery located inside the indicator or plugged into an acceptable power outlet. Battery life is approximately 107 hours with the backlight off.

When the battery needs charging this symbol, , appears in the upper left corner of the weight display. The scale will still operate for about 10 hours after which it will automatically switch off to protect the battery.

When the scale is turned on, the battery status is:

- Green LED, the battery is fully charged;
- Red LED, the battery is low and needs to be recharged.

Do not use any other type of power adaptor other than the one supplied with the scale and verify that the AC power socket outlet is properly protected.

 **Charge the battery before using (+12hrs).**

2.4. Powering ON/OFF the Scale





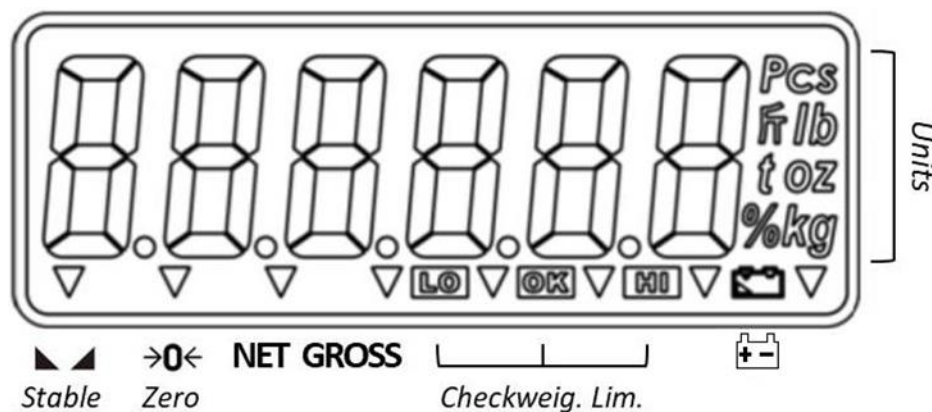

With the platform connected and the battery fully charged or the charger plugged into the indicator, press the **ON** key to power ON the scale. A display test will be performed on power up and the scale will finish in normal weighing mode. Press the **OFF** key to turn the scale off.

2.5. Front Panel

The indicator has a sealed keypad and a 6 digits LCD display 0.59" (40mm) high with a white backlight. Only the active annunciators are shown below.



2.5.1. Display Annunciators

	Display reading is stable
	Scale at Zero
NET	Indicates a Net weight
GROSS	Indicates a Gross weight
	Under acceptable weight range
	Within acceptable weight range
	Over acceptable weight range
	Battery needs to be recharged
kg lb g Pcs	Current unit of measure

2.5.2. Operation Keys

Keys are shown below along with their functions. Some keys have secondary functions.



Press and hold the **OFF** key to turn off the scale. "oFF" will be displayed for 2 seconds.



Press the **ON** key to turn on the scale.
The scale will run through a display test before displaying 0.000.



- Press the **UNITS** key to scroll through the active units of measure.
- **In Menu mode:** It aborts a numeric entry and acts as an ESCAPE key (ESC).



- Press the **ZERO** key to zero the scale. Enabled only within the $\pm 2\%$ range of capacity.
- **In Menu mode:** It acts as a left arrow key (◀).



- Press the **TARE** key to perform a tare function.
- **In Menu mode:** It acts as a right arrow key (▶).



- Press the **SELECT** key to toggle between the operating modes enabled.
- **In Menu mode:** It increments a numeric value (▲).



- Press the **PRINT** key to send information to a peripheral device.
- **In Menu mode:** It acts as an ENTER key to accept a displayed value or function (↵).

2.6. Error Codes

Err H	Initial zero too high (+10% of full cap. see LF-2)
Err L	Initial zero too low (-10% of full cap. see LF-2)
Err N	Unstable internal count, this may indicate the load cell or electronics are faulty
Err Z	Out of Zero range (+2% of full cap.)
Err 4	EEPROM failure, this may indicate the indicator is faulty
-OL-	Overload, full capacity +9d
-UL-	Underload, zero cal. -20d

3. Scale Operation

This section covers the scale operations of simple weighing, counting and hold. The steps for various kinds of weighing are explained in the following pages.

! *A warm-up time of 15 minutes is required to stabilize the measured values.*

3.1. Gross Weighing

To perform a gross weighing, follow these steps:

1. Power up the scale. Be sure the scale is displaying weight in the correct unit of measure. Press the **UNITS** key, if necessary to change the units of measure the scale is working in.
2. Zero the scale if necessary by pressing the **ZERO** key. If the weight change is within the Zero window area the display will show **0.000**. Decimal positions available may vary.
3. Place the item(s) to be weighed on the scale platform.
4. The display will now display the weight of the item that is on the weight platter

3.2. Tare Weighing

If you want to do NET weighing, such as weighing objects in a container, follow these steps:

1. Power up the scale. Be sure the scale is displaying weight in the correct unit of measure. Press the **UNITS** key, if necessary to change the units of measure the scale is working in.
2. Zero the scale if necessary by pressing the **ZERO** key. If the weight change is within the Zero window area the display will show **0.000**. Decimal positions available may vary.
3. Place the item to be tared on the scale platform.
4. Press the **TARE** key. If the container weight is outside the Zero window area the display will show **0.000** weight and the NET annunciator is illuminated. Decimal positions available may vary.
5. Place the item to be weighed on the scale platform. The Net weight of the item is displayed. Press the **SELECT** key to choose the Gross or Net weight.

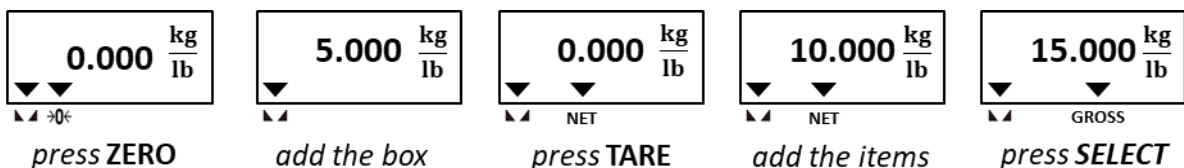

Example: annunciators lit when tare weighing with 5 kg box and 10 kg of items.

3.2.1. Clear a Tare

Remove any load from the scale and press the **TARE** key until **0.000** is displayed. Decimal positions available may vary.

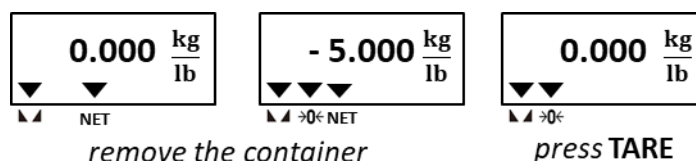

Example: annunciators lit when clearing a 5 kg container tare

3.3. Counting Mode

The ZM110 Counting mode has been designed to allow the operator to easily carry out basic sampling and counting routines on this scale even if the scale is mainly used for general weighing applications. By pressing the units' key until Pcs is illuminated on the display, the scale can now be quickly used to sample parts ready for counting.

! *For count accuracy, all items should be uniform in weight and UF-5 set as HOLD 0. It is recommended that the sample weight be a minimum of 0.1% of scale capacity.*

3.3.1. Sampling Parts Prior to Counting

Follow these steps to count items using the sampling method.

1. Power up and if necessary Zero the scale by pressing the **ZERO** key. If the weight change is within the Zero window area the display will show **0.000**. Decimal positions available may vary.
2. Press the **UNITS** key until **0 Pcs** is displayed.
3. Press **SELECT** to choose the sample size from: **10, 20, 50, 100 and 200**.
4. Manually count the sample of parts onto the scale to the agreed sample size and press the **PRINT** key to confirm.
5. Place the remaining parts onto the scale platform to Count Parts. The display will show the number of parts on the scale.

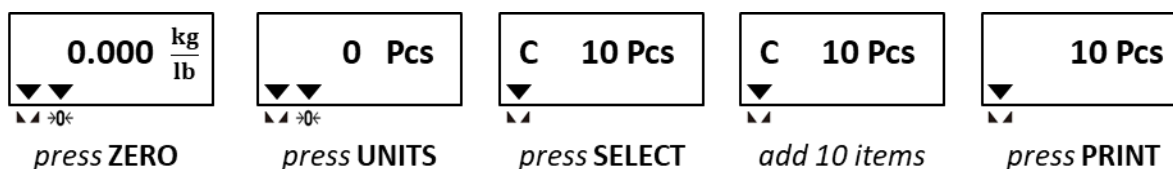

Example: annunciators lit at steps: 1, 2, 3 and 4 when sample size 10 Pcs

Counting can also be done while using a tare following these steps:

- i. After you have set the piece weight place the empty container on the empty scale and press the **TARE** key.
- ii. The scale will Zero the display and illuminate the Net annunciator. Place the parts to be counted into the container and read off the net count value.

3.3.2. Check Counting

Make sure that the unit of measure is **PCs** and follow the instructions in section 3.4.1, page 14.

3.4. Checkweighing Mode

Checkweighing is a function that allows the operator to quickly see if a product is within an agreed acceptable tolerance, ideal for fast repetitive work where accuracy is important.

By setting upper and lower acceptable weight or count limits for a product the scale can be used to check for regular weight or count conformity.

To set the limits and beeper mode, see chapters 3.4.1. and 3.4.2. on page 14.

To perform a gross weighment, follow these steps:

1. Power up the scale. Be sure the scale is displaying weight in the correct unit of measure. Press the **UNITS** key, if necessary to change the units of measure the scale is working in.
2. Zero the scale if necessary by pressing the **ZERO** key. If the weight change is within the Zero window area the display will show **0.000**. Decimal positions available may vary.
3. Place the item to be checkweighed on the scale platform.
The weight is displayed and either the **LO**, **OK** or **HI** annunciator will be illuminated letting the operator quickly see if the item being weighed is within an acceptable weight tolerance to proceed.
4. Remove item from the scale platform and repeat steps 3 and 4 for each item to be checkweighed.

Checkweighing can also be done while using a tare. After you have Zero the scale (step 2), place the item to be tared on the scale, press the **TARE** key and continue with checkweighing as described in steps 3 and 4.

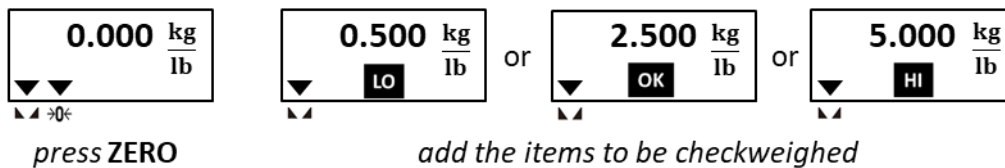

Example: annunciators lit when acceptable limits are: LO < 1.00 kg and HI > 4.00 kg

3.4.1. Setting the Checkweighing Limits

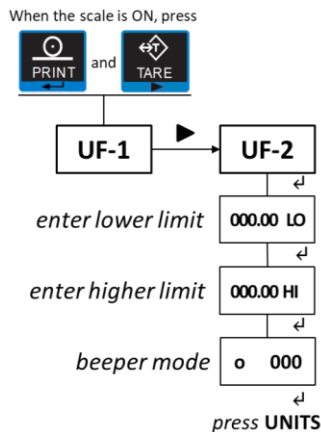

- i. When the scale is ON, press the **PRINT** and **TARE** keys together; **UF-1** will be displayed.
- ii. Press **TARE** (▶) key; **UF-2** will be displayed.
- iii. Press **PRINT**(↵) key;
- iv. Enter or edit the **LO** limit value by pressing the **ZERO**(◀) and/or **TARE** (▶) keys to move the flashing digit left or right and press the **SELECT** (▲) key to increase the numeric value;
- v. Press the **PRINT** (↵) key to confirm;
- vi. Repeat points *iv.* and *v.* for the **HI** limit;
- vii. Choose the **beeper mode** [000; 001; 002; see section 3.4.2 Table] by pressing the **ZERO**(◀) and/or **TARE** (▶) keys to move the flashing digit left or right and press the **SELECT** (▲) key to increase the numeric value;
- viii. Press the **PRINT** (↵) key to complete and leave the procedure;
- ix. Press the **UNITS** (BSC) key to exit the User Menu.

ⓘ **To disable the Checkweighing mode, set the LO limit to 0 under the UF-2 menu and press the PRINT (↵) key to confirm. To exit the User Menu, press UNITS (BSC).**
The LO and HI annunciators may vary. The illustration shows the annunciators displayed when acceptable limits are entered for the first time.

3.4.2. Checkweighing Beeper Modes

There are three modes.

- | | |
|-------|--|
| o 000 | The beeper is disabled. |
| o 001 | The beeper tones only when the load is <u>within</u> acceptable limits. |
| o 002 | The beeper tones only when the load is <u>outside</u> the acceptable limits. |

ⓘ **Please, ignore any other mode not listed above.**

3.5. Hold Mode for Animal Weighing

This function can be used to capture and hold stable weight/pcs values. The indicator temporarily freezes (Hold) the value on the screen for the user to view or record.

To enable the Hold mode, see chapter 3.5.1

To perform a Hold weighment, follow these steps:

1. Power up the scale and zero the display, if necessary, by pressing the **ZERO** key. Be sure the scale is displaying weight in your preferred unit of measure. Press the **UNIT** key, if necessary.

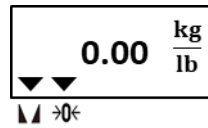

2. Open the User Menu and select the *Hold* function [UF-5] to enable the option [Hold 1]. See the instructions below.
3. Place the item(s)/animal to be weighed/counted on the scale platform.

The indicator captures the weight.

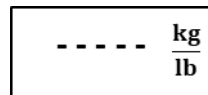

The indicator freezes the stable weight.

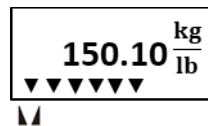

4. Removing the item(s)/animal from the scale platform will clear the hold weight.

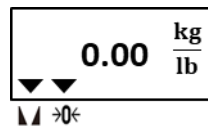

5. Repeat the steps above for other *Hold* weighments.

To disable the *Hold* mode, open the User Menu and select the *Hold* function [UF-5], option [Hold 0]. In *Hold* mode, the Tare and, Zero keys are not available.

The *Hold – Animal Weighing* mode can be used in combination with the *Checkweighing* function [UF-2].

3.5.1 Setting the Hold mode

When the scale is ON, press

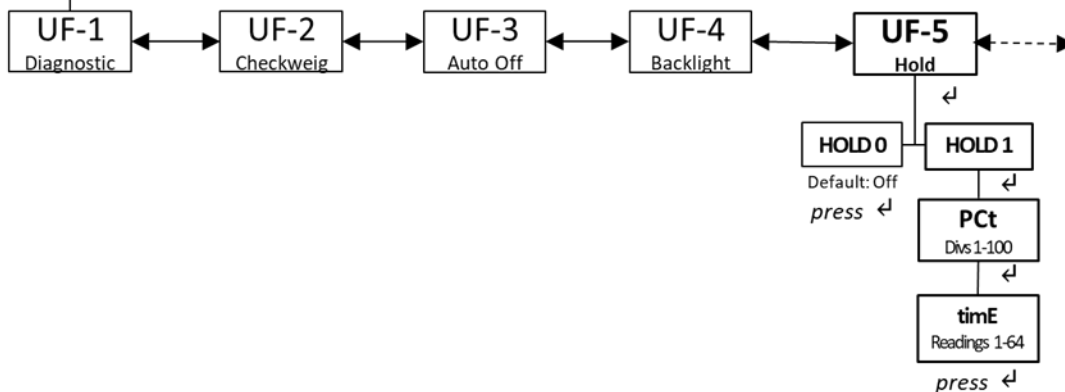

Open the User Menu and select the *Hold* function [UF-5] to enable the option [Hold 1].

Settings:

- **PCt** is the stability weight window in number of divisions. PCt range = 1 to 100 divs.
- **timE** is the number of consecutive weight readings within the stability window to be classed as stable weight. The average of these weight readings is the hold weight that the indicator will display. timE range = 1 to 64.

For example, a smaller PCt value sets a tighter stability window in which the stable weight has to be captured timE number of times.

Valid modes are HOLD 0 and HOLD 1 only. Recommended starting settings: **PCt 100** and **timE 4**. Then adjust to meet the weighing application requirements.

3.5.2 Hold Mode Examples

PCt = 20 divisions, stability window

timE =16 weight readings to be taken from within the stability window

The hold weight displayed is the last weight reading **(H)** taken from within the stability window.

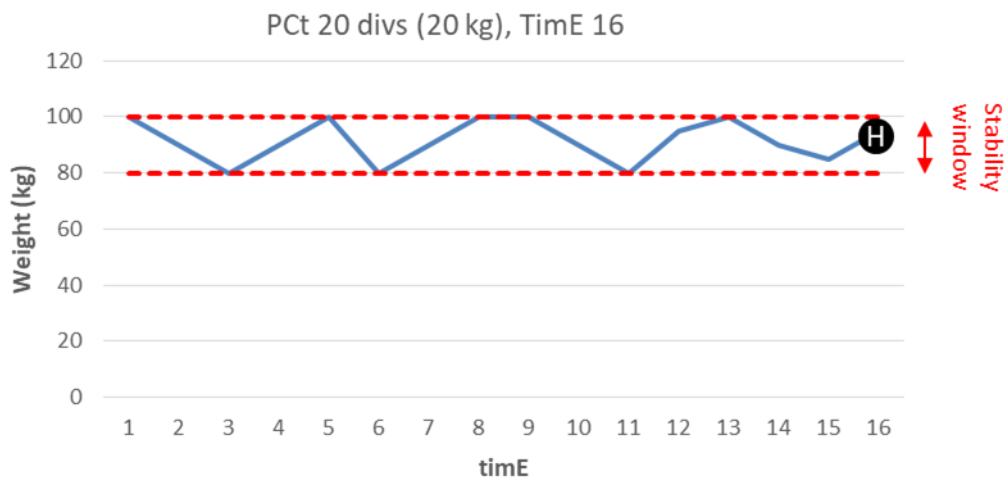

Note: a smaller PCt value sets a tighter stability window in which the stable weight has to be captured timE number of times.

PCt = 20 divisions, stability window

timE =16 16 weight readings to be taken from within the stability window

The hold weight displayed is the last weight reading **(H)** taken from within the stability window.

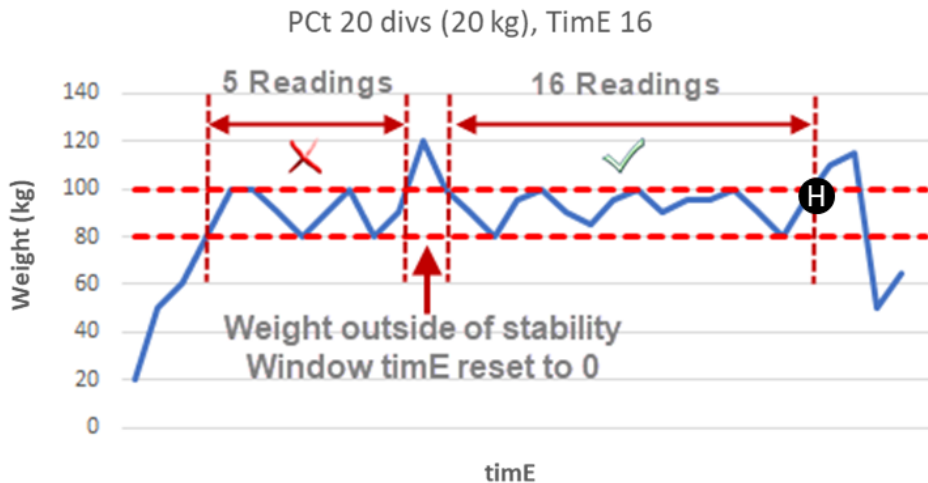

Removing the item(s)/animal from the scale platform will clear the hold weight.

4. Menus

There are three menus that allow configuring, enabling and executing specific functions or options.

- | | pages |
|--|-----------|
| • User Menu <i>UF- 1 ~ 11</i> | 17 |
| • Supervisor Menu See Service Manual ZM110_s_en_501813.pdf | 19 |
| • Quick Calibration Menu See Service Manual ZM110_s_en_501813.pdf | 19 |

4.1. User Menu

In the User Menu there are various submenus available to configure specific sections of the scale operating modes, including a diagnostic feature.

4.1.1. User Menu Levels [UF]

Navigate the options by pressing **ZERO** (◀), **TARE** (▶) and increase a numeric value by **SELECT** (▲) key. Press **UNITS** (esc) to exit the option or the menu and **PRINT** (↵) key to confirm.

When the scale is ON, press

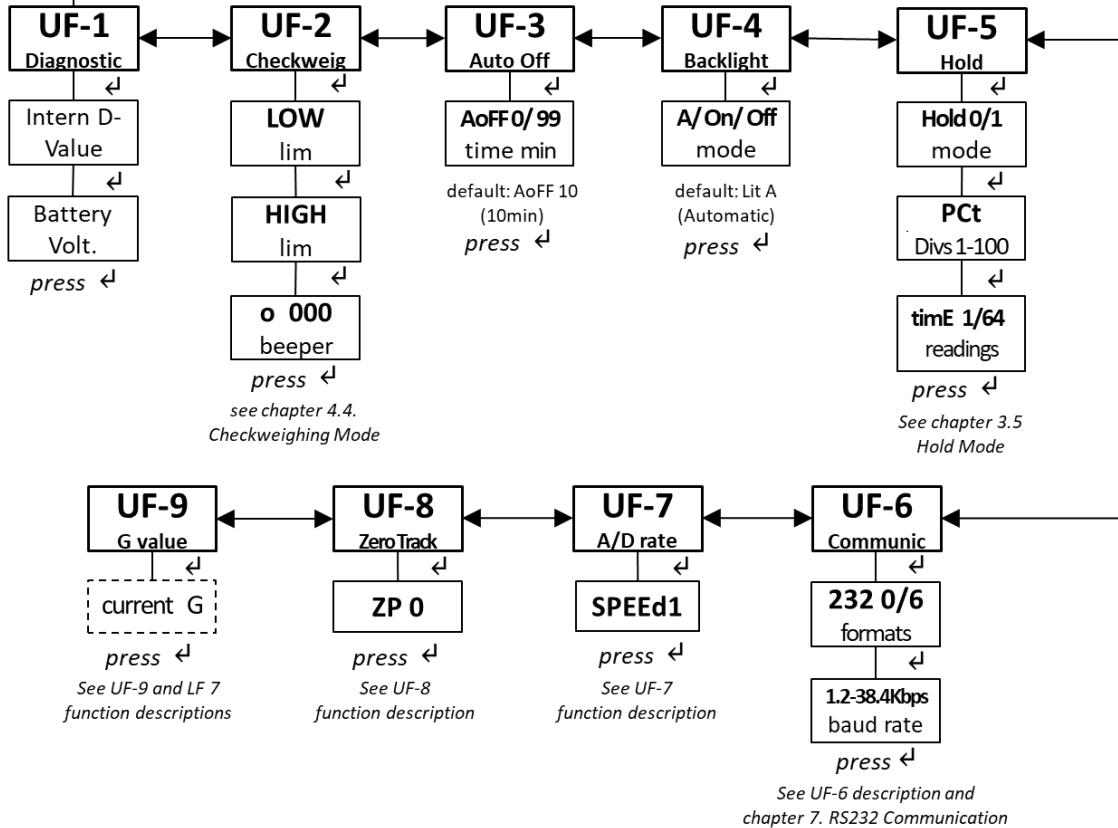
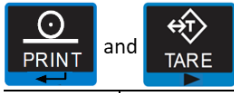

4.1.2. User Functions Descriptions [UF]

There are 9 Setup Functions.

-
- UF-1 Diagnostic:** use this menu to check or verify the performance of the indicator. The diagnostic tests available include: Scale A to D to view output from the connected scale base or load device, *Internal D-Value*, and *Battery Voltage*.
-
- UF-2 Checkweighing:** the acceptable weight is any weight which falls between the upper and lower limits. Enter this option to set the items relating to checkweighing:
- *LOW / HIGH* limits. Valid beeper modes: o 000; o 001; o 002.
- See chapter 3.4. Checkweighing Mode on page 13.
-
- UF-3 Auto Power-Off:** use this to set the length of time before the scale automatically turns off if not being used. Values can be set between 01 and 99 minutes.
Factory default: AoFF 10 (10min). Auto Power-OFF is disabled when *AoFF 00*
-
- UF-4 Backlight:** use this to set the light mode:
- OFF / Automatic / ON
-

Factory default: Lit A (automatic)

UF-5 Hold / Animal Weighing Mode: use this to enable and configure the Hold parameters:

- Hold 0 / Hold 1

Factory default: Hold 0 (disabled)

See chapter 3.5 Hold Mode on page 14.

UF-6 RS232 Output: use this to configure the communication port items:

Factory default: 232 0 (disabled)

See Service Manual ZM110_s_en_501813.pdf

UF-7 ADC Update Rate: *Factory default: SPEEd 1 (standard 15Hz)*

See Service Manual ZM110_s_en_501813.pdf

UF-8 Zero Tracking: *Factory default: ZP 0 (off)*

See Service Manual ZM110_s_en_501813.pdf

UF-9 Gravitational value: use this item to key in a gravity constant value.

-  **CAUTION!** This item is locked when the calibration switch is at position OFF.
See Service Manual ZM110_s_en_501813.pdf
-

4.2. Supervisor Menu

In the Supervisor Menu there are various submenus available to configure system parameters, specific sections of the operating modes and the calibration feature.

See Service Manual ZM110_s_en_501813.pdf

4.3 Quick Calibration Menu

It is recommended to perform only the very first calibration following the function **LF 1** in the **Supervisor Menu**. To prevent any unintentional amendment of the scale configuration, all the next Calibration should be performed by entering the **Quick Calibration Menu**. See Service Manual ZM110_s_en_501813.pdf

Note: perform the linearity procedure only if test weights applied to the scale between the zero and span calibration points are showing slight inaccuracies, such as \pm a few divisions. If large inaccuracies are recorded, this indicates a possible mechanical problem or possible load cell failure which linearity calibration may not be able to correct.

-  **For trade-approved applications, the indicator has to be properly configured by entering the functions available in the Supervisor Menu before setting the Calibration Switch at SEALED and sealing the indicator. See Service Manual ZM110_s_en_501813.pdf**

5. Scale Configuration [LF 2]

Enter the function **LF 2** under the **Supervisor Menu** to set the units, counting mode, calibration units, the decimal position of the separator and division size.

See Service Manual ZM110_s_en_501813.pdf

6. RS232 Communications

RS232 allows the scale to communicate with a remote peripheral device such as a printer or computer. RS232 kit p/n AWT15-501905. See Service Manual ZM110_s_en_501813.pdf

6.1 Output Specifications

- RS-232 output of weighing data
- ASCII code
- 8 data bits
- Parity None, Stop Bit 1
- Baud rate from 1200bps to 38400bps. If enabled the default baud rate is 9600bps.

7. Replacement Parts

See Service Manual ZM110_s_en_501813.pdf

8. Loadcell Pinouts

LOADCELL connection (for indicator)

PIN 1 : Ex + (Red)

PIN 2 : Sense + (Brown)

PIN 3 : Ex- (Black)

PIN 4 : Sense - (Grey)

PIN 5 : Sig + (Green)

PIN 6 : GND (screen/Yellow)

PIN 7 : Sig – (White/Orange)

Avery Weigh-Tronix



Avery Weigh-Tronix USA

1000 Armstrong Dr.
Fairmont MN 56031 USA
Tel:507-238-4461
Fax:507-238-4195
Email: usinfo@awtxglobal.com
www.wtxweb.com

Avery Weigh-Tronix UK

Foundry Lane,
Smethwick, West Midlands,
England B66 2LP
Tel:+44 (0) 8453 66 77 88
Fax: +44 (0)121 224 8183
Email: info@awtxglobal.com
www.averyweigh-tronix.com