



SBI-240 Weighing Indicator



Service Manual

Brecknell is part of Avery Weigh-Tronix. Avery Weigh-Tronix is a trademark of the Illinois Tool Works group of companies whose ultimate parent company is Illinois Tool Works Inc ("Illinois Tool Works"). Copyright © 201, Illinois Tool Works. All rights reserved.

No part of this publication may be reproduced by making a facsimile copy, by the making of a copy in three dimensions of a two-dimensional work and the making of a copy in two dimensions of a three-dimensional work, stored in any medium by electronic means, or transmitted in any form or by any means, including electronic, mechanical, broadcasting, recording or otherwise without the prior written consent of the copyright owner, under license, or as permitted by law.

This publication was correct at the time of going to print, however Avery Weigh-Tronix reserves the right to alter without notice the specification, design, price or conditions of supply of any product or service at any time.

Table of Contents

Chapter 1 General Information and Warnings	6
About this Manual	6
Text Conventions	6
Special Messages	6
Warnings	7
Routine Maintenance	8
Sharp Objects	8
Cleaning the Indicator	8
CE Certification	8
Chapter 2 Installation	9
Contents	9
Connectors and Jumpers	10
Power Supply	10
Definition of Connectors and Jumpers	10
Chapter 3 Scale Operation	13
Front Panel	13
Keys	14
Turn the Indicator ON	16
Turn the Indicator OFF	16
Navigating the Weigh Mode	16
Changing the Working Mode	16
Normal Weighing Mode	16
Zero	16
Setting a Tare Weight	17
Setting a Pre-determined Tare Weight	17
Change Weight Unit	17
Output Data (print to a computer or printer)	19
Display Gross or Net Weight	19
Check Weight (data compare)	19
Accumulation Mode	20
Count Mode	21
Enter a Known Piece Weight Directly	21
Enter the Piece Weight with a Sample of a Known Quantity	22
Check Counts (count compare) in Counting Mode	23
Percent Weighing Mode	24
Using an Entered Weight and Percentage	24
Using Weight Samples when Percentage is Known	25
Check Percent (percentage compare)	26
BMI Working Mode	27
Weight Fine-tune	28
HOLD Function	29
Positive Peak HOLD	29
Negative Peak HOLD	30
Toggle HOLD	30
Average HOLD	30
Auto HOLD (default setting)	30
Chapter 4 Setup Mode	31
Entering the Setup Menu	31
Navigating the Setup Menu	31
Setup Menu Parameters	32

CONFIG Menu	33
USER Menu	38
CAL Menu	48
MISC Menu	50
TEST Menu	50
Exit the Setup Menu	51
Chapter 5 Calibration	52
Enter the Calibration Mode	52
ZERO Calibration	52
Linearity Calibration	53
Geographical Adjustment	54
Input or View Calibration	56
Display ADC Output Code	57
Chapter 6 Serial Communication	58
Communication Details	58
Transaction String	58
Commands and Response	60
User - Com 1/2 Layout	60
Parameter Multpl	62
Parameter EH-S	64
Parameter SCP-12 (NCI3835).....	65
Output Print Formats	66
UPS Worldship	67
Chapter 7 Test	68
Display Test	68
Serial Port 1/2 (COM1/2) Receiving Test	68
Serial Port 1/2 (COM1/2) Transmitting Test	68
Keyboard and Buzzer Test	69
Chapter 8 Troubleshooting	70
Display Characters	70
Display Symbols	71
Error Messages and Troubleshooting	72
Replacement Parts	73

1 General Information and Warnings

1.1 About this Manual

This manual is divided into chapters by the chapter number and the large text at the top of a page. Subsections are labeled as shown by the 1 and 1.1 headings shown above. -The names of the chapter and the next subsection level appear at the top of alternating pages of the manual to remind you of where you are in the manual. The manual name and page numbers appear at the bottom of the pages.

1.1.1 Text Conventions

The keys used to interface with weighing scales are located on the front panel of the indicator. The keystrokes are shown in **BOLD** encased between brackets. (e.g. **[ZERO]**)

Displayed messages appear in seven segment display type and reflect the case of the displayed message. (e.g. \overline{L} \overline{O} \overline{P} \overline{F} \overline{I} \overline{G})

1.1.2 Special Messages

Examples of special messages you will see in this manual are defined below. The signal words have specific meanings to alert you to additional information or the relative level of hazard.



CAUTION!

This is a Caution symbol.

Cautions give information about procedures that, if not observed, could result in damage to equipment or corruption to and loss of data.



ELECTRICAL WARNING!

THIS IS AN ELECTRICAL WARNING SYMBOL.

ELECTRICAL WARNINGS MEAN THAT FAILURE TO FOLLOW SPECIFIC PRACTICES OR PROCEDURES MAY RESULT IN ELECTROCUTION, ARC BURNS, EXPLOSIONS OR OTHER HAZARDS THAT MAY CAUSE INJURY OR DEATH.



NOTE: This is a Note symbol. Notes give additional and important information, hints and tips that help you to use your product.

1.2 Warnings



ELECTRICAL WARNING!
RISK OF ELECTRICAL SHOCK: DISCONNECT ALL POWER SOURCES BEFORE MAKING CABLE CONNECTIONS TO THE FLOOR SCALE PLATFORM OR INDICATOR.

FOR USE IN DRY ENVIRONMENTS ONLY.



CAUTION!

Do not operate in hazardous areas.

- | Read and understand all operating instructions before using this product. Keep this manual for future reference.
- | Record the weight shortly after placing a load on the platform. After extended periods, the loadcell output signal may result in a less accurate reading.
- | Avoid extended exposure to extreme heat or cold. Optimum operation is at normal room temperature. See operating temperature range in the specifications table. Allow the scale to acclimate to room temperature before using.
- | Allow sufficient warm up time. Turn the scale on and allow up to 2 minutes for internal components to stabilize before weighing.
- | Electronic indicators are precision instruments. Do not operate near cell phones, radios, computers or other electronic devices that emit radio frequencies that may cause unstable readings.
- | This equipment has been tested and found to comply with the limits for a Class A digital device, pursuant to Part 15 of the FCC Rules. These limits are designed to provide reasonable protection against harmful interference when the equipment is operated in a commercial environment. This equipment generates, uses, and can radiate radio frequency energy and, if not installed and used in accordance with this manual, may cause harmful interference to radio communications. Operation of this equipment in a residential area is likely to cause harmful interference, in which case the user will be required to correct the interference at their own expense.

- Avoid using in heavy vibration or heavy airflow conditions. This also applies when the equipment is integrated into conveying systems.

1.3 Routine Maintenance



IMPORTANT: This equipment must be routinely checked for proper operation and calibration. Application and usage will determine the frequency of calibration required for safe operation.

Always turn off the machine and isolate from the power supply before starting any routine maintenance to avoid the possibility of electric shock.

1.4 Sharp Objects

Do not use sharp objects such as screwdrivers or long fingernails to operate the keys.



1.5 Cleaning the Indicator

Table 1.1 Cleaning DOs and DON'Ts





DO	DO NOT
Wipe down the outside of standard products with a clean cloth, moistened with water and a small amount of mild detergent	Attempt to clean the inside of the indicator
	Use harsh abrasives, solvents, scouring cleaners or alkaline cleaning solutions
Spray the cloth when using a proprietary cleaning fluid	Spray any liquid directly on to the display window

1.6 CE Certification

EN	EU Declaration of Conformity
Model / Type: SBI-240 & DSB	
Name and address of the manufacturer: Avery Weigh-Tronix¹ Foundry Lane Smethwick West Midlands B66 2LP ENGLAND	
This declaration of conformity is issued under the sole responsibility of the manufacturer	
Object of the declaration: Brecknell² SBI-240 (816965006960) DSB3636-2.5/SBI-240 (816965006915) DSB4848-05/SBI-240 (816965006922) DSB6060-05/SBI-240 (816965006939) DSB4848-10/SBI-240 (816965006946) DSB6060-10/SBI-240 (816965006953) 816965002061 / 2887 816965005437 / 5451 / 5468 / 6991 AWT05-507338 1140-13842	
	
The object of the declaration described above is in conformity with the relevant Union harmonisation legislation:	
Applicable Directives	Harmonised standards or other technical specifications
2014/30/EU Electromagnetic Compatibility	EN61326-1:2013 EN61000-3-2:2014 EN61000-3-3:2013
2014/35/EU Electrical equipment designed for use within certain voltage limits	EN60950-1:2006 +A2:2013
2011/65/EU Restriction of the use of certain hazardous substances in electrical and electronic equipment	EN 50581:2012
Additional information: Note¹: ITW Ltd trading as Avery Weigh-Tronix Reg. Office: Nexus House, Station Road, Egham, Surrey, TW20 9LB, England Note²: Brecknell is part of Avery Weigh-Tronix	
Signed for and on behalf of: Avery Weigh-Tronix at 1000 Armstrong Drive, Fairmont, MN, 56031-1439, USA on 2017-09-06	
	
K. Detert Innovations/Marketing Director	

DE	EU- Konformitätserklärung
Modell / Typen: SBI-240 & DSB	
Name und Anschrift des Herstellers: Avery Weigh-Tronix¹ Foundry Lane Smethwick West Midlands B66 2LP ENGLAND	
Die alleinige Verantwortung für die Ausstellung dieser Konformitätserklärung trägt der Hersteller.	
Gegenstand der Erklärung: Brecknell² SBI-240 (816965006960) DSB3636-2.5/SBI-240 (816965006915) DSB4848-05/SBI-240 (816965006922) DSB6060-05/SBI-240 (816965006939) DSB4848-10/SBI-240 (816965006946) DSB6060-10/SBI-240 (816965006953) 816965002061 / 2887 816965005437 / 5451 / 5468 / 6991 AWT05-507338 1140-13842	
	
Der oben beschriebene Gegenstand der Erklärung erfüllt die einschlägigen Harmonisierungsrechtsvorschriften der Union:	
Angewandte Richtlinien	Harmonisierte Normen oder sonstigen technischen Spezifikationen
2014/30/EU Elektromagnetische Verträglichkeit	EN61326-1:2013 EN61000-3-2:2014 EN61000-3-3:2013
2014/35/EU Elektrischer Betriebsmittel zur Verwendung innerhalb bestimmter Spannungsgrenzen	EN60950-1:2006 +A2:2013
2011/65/EU Beschränkung der Verwendung bestimmter gefährlicher Stoffe in Elektro- und Elektronikgeräten	EN 50581:2012
Zusatzangaben: Anmerkung¹: ITW Ltd Handel als Avery Weigh-Tronix Sitz: Nexus House, Station Road, Egham, Surrey, TW20 9LB, England Anmerkung²: Brecknell ist ein Teil von Avery Weigh-Tronix	
Unterzeichnet für und im Namen von: Avery Weigh-Tronix bei 1000 Armstrong Drive, Fairmont, MN, 56031-1439, USA am 2017-09-06	
	
K. Detert Innovationen / Marketingdirektor	

FR	Déclaration UE de Conformité
Modèle / Type: SBI-240 & DSB	
Nom et adresse du fabricant : Avery Weigh-Tronix¹ Foundry Lane Smethwick West Midlands B66 2LP ANGLETERRE	
La présente déclaration de conformité est établie sous la seule responsabilité du fabricant.	
Objet de la déclaration: Brecknell² SBI-240 (816965006960) DSB3636-2.5/SBI-240 (816965006915) DSB4848-05/SBI-240 (816965006922) DSB6060-05/SBI-240 (816965006939) DSB4848-10/SBI-240 (816965006946) DSB6060-10/SBI-240 (816965006953) 816965002061 / 2887 816965005437 / 5451 / 5468 / 6991 AWT05-507338 1140-13842	
	
L'objet de la déclaration décrit ci-dessus est conforme à la législation d'harmonisation de l'Union applicable:	
Les directives en vigueur	Les normes harmonisées ou d'autres spécifications techniques
2014/30/UE Compatibilité Électromagnétique	EN61326-1:2013 EN61000-3-2:2014 EN61000-3-3:2013
2014/35/UE Matériel électrique destiné à être employé dans certaines limites de tension	EN60950-1:2006 +A2:2013
2011/65/UE La limitation de l'utilisation de certaines substances dangereuses dans les équipements électriques et électroniques	EN 50581:2012
Informations complémentaires: Nota¹: ITW Ltd exerçant également sous le nom de Avery Weigh-Tronix Siège social: Nexus House, Station Road, Egham, Surrey, TW20 9LB, Angleterre Nota²: Brecknell fait partie d'Avery Weigh-Tronix	
Signé par et au nom de: Avery Weigh-Tronix à 1000 Armstrong Drive, Fairmont, MN, 56031-1439, USA le 2017-09-06	
	
K. Detert Innovations / Directeur Marketing	

NL	EU- Conformiteitsverklaring
Model / Type: SBI-240 & DSB	
Naam en adres van de fabrikant : Avery Weigh-Tronix¹ Foundry Lane Smethwick West Midlands B66 2LP ENGLAND	
Deze conformiteitsverklaring wordt verstrekt onder volledige verantwoordelijkheid van de fabrikant.	
Voorwerp van de verklaring: Brecknell² SBI-240 (816965006960) DSB3636-2.5/SBI-240 (816965006915) DSB4848-05/SBI-240 (816965006922) DSB6060-05/SBI-240 (816965006939) DSB4848-10/SBI-240 (816965006946) DSB6060-10/SBI-240 (816965006953) 816965002061 / 2887 816965005437 / 5451 / 5468 / 6991 AWT05-507338 1140-13842	
Het hierboven beschreven voorwerp is in overeenstemming met de desbetreffende harmonisatiewetgeving van de Unie:	
Toepasselijke richtlijnen	Geharmoniseerde standaarden of andere technische specificaties
2014/30/EU Elektromagnetische compatibiliteit	EN61326-1:2013 EN61000-3-2:2014 EN61000-3-3:2013
2014/35/EU Elektrisch materiaal bestemd voor gebruik binnen bepaalde spanningsgrenzen	EN60950-1:2006 +A2:2013
2011/65/EU Beperking van het gebruik van bepaalde gevaarlijke stoffen in elektrische en elektronische apparatuur	EN 50581:2012
Aanvullende informatie: Noot¹: ITW Ltd trading als Avery Weigh-Tronix Zetel: Nexus House, Station Road, Egham, Surrey, TW20 9LB, England Noot²: Brecknell is een onderdeel van Avery Weigh-Tronix	
Ondertekend voor en namens: Avery Weigh-Tronix bij 1000 Armstrong Drive, Fairmont, MN, 56031-1439, VS op 2017-09-06	
K.Detert Innovaties / Marketing Director	

IT	Dichiarazione di Conformità UE
Modello / Tipo: SBI-240 & DSB	
Nome e indirizzo del fabbricante: Avery Weigh-Tronix¹ Foundry Lane Smethwick West Midlands B66 2LP INGILTERRA	
La presente dichiarazione di conformità è rilasciata sotto la responsabilità esclusiva del fabbricante.	
Oggetto della dichiarazione: Brecknell² SBI-240 (816965006960) DSB3636-2.5/SBI-240 (816965006915) DSB4848-05/SBI-240 (816965006922) DSB6060-05/SBI-240 (816965006939) DSB4848-10/SBI-240 (816965006946) DSB6060-10/SBI-240 (816965006953) 816965002061 / 2887 816965005437 / 5451 / 5468 / 6991 AWT05-507338 1140-13842	
L'oggetto della dichiarazione di cui sopra è conforme alla pertinente normativa di armonizzazione dell'Unione:	
Direttive applicabili	Armonizzato standard o altre specificazioni tecniche
2014/30/UE Compatibilità elettromagnetica	EN61326-1:2013 EN61000-3-2:2014 EN61000-3-3:2013
2014/35/UE Materiale elettrico destinato a essere adoperato entro taluni limiti di tensione	EN60950-1:2006 +A2:2013
2011/65/UE Restrizione dell'uso di determinate sostanze pericolose nelle apparecchiature elettriche ed elettroniche	EN 50581:2012
Informazioni supplementari: Nota¹: ITW Ltd trading come Avery Weigh-Tronix Sede dell'ufficio: Nexus House, Station Road, Egham, Surrey, TW20 9LB, England Nota²: Brecknell è parte di Avery Weigh-Tronix	
Firmato a nome e per conto di: Avery Weigh-Tronix a 1000 Armstrong Drive, Fairmont, MN, 56031-1439, U.S.A. su 2017-09-06	
K.Detert Innovations / Direttore Marketing	

ES	Declaración UE de Conformidad
Modelo / Tipo: SBI-240 & DSB	
Nombre y dirección del fabricante Avery Weigh-Tronix¹ Foundry Lane Smethwick West Midlands B66 2LP INGLATERRA	
La presente declaración de conformidad se expide bajo la exclusiva responsabilidad del fabricante.	
Objeto de la declaración: Brecknell² SBI-240 (816965006960) DSB3636-2.5/SBI-240 (816965006915) DSB4848-05/SBI-240 (816965006922) DSB6060-05/SBI-240 (816965006939) DSB4848-10/SBI-240 (816965006946) DSB6060-10/SBI-240 (816965006953) 816965002061 / 2887 816965005437 / 5451 / 5468 / 6991 AWT05-507338 1140-13842	
El objeto de la declaración descrita anteriormente es conforme con la legislación de armonización pertinente de la Unión:	
Directivas aplicables	Normas armonizadas u otras especificaciones técnicas
2014/30/UE Compatibilidad electromagnética	EN61326-1:2013 EN61000-3-2:2014 EN61000-3-3:2013
2014/35/UE Material eléctrico destinado a utilizarse con determinados límites de tensión	EN60950-1:2006 +A2:2013
2011/65/UE Restricciones a la utilización de determinadas sustancias peligrosas en aparatos eléctricos y electrónicos	EN 50581:2012
Información adicional: Nota¹: ITW Ltd trading as Avery Weigh-Tronix Oficina registrada: Nexus House, Station Road, Egham, Surrey, TW20 9LB, Angleterre Nota²: Brecknell es parte de Avery Weigh-Tronix	
Firmado en nombre de: Avery Weigh-Tronix en 1000 Armstrong Drive, Fairmont, MN, 56031-1439, EE.UU el 2017-09-06	
K.Detert Innovaciones / Director de Marketing	

2 Installation



DANGER: RISK OF ELECTRICAL SHOCK. BE SURE TO UPLUG THE INDICATOR BEFORE REMOVING THE COVER OR OPENING THE UNIT. REFER TO QUALIFIED SERVICE PERSONNEL FOR SERVICE.

2.1 Contents

- Indicator
- 9V 600mA adapter
- UK, EU,US adapter plugs
- Service Manual

2.4 Connectors and Jumpers

There are connectors located on the bottom side of indicator for the power supply, USB port, RS-232 serial port and display which is used for mounting the display remotely on a wall or a desk.

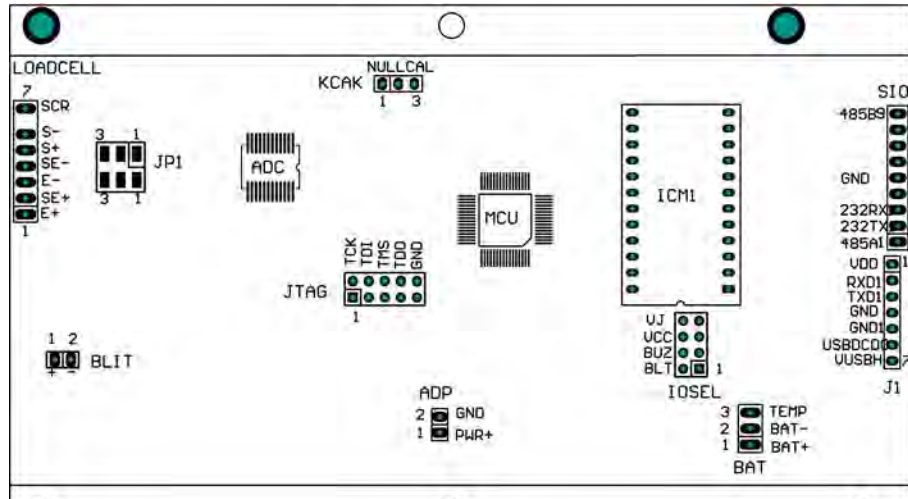

Figure 2.1 View of PC Board Connectors

2.4.1 Power Supply

The indicator comes with an external AC to DC power adapter. Simply plug the AC adapter into the DC9V power jack on the scale and then plug into a standard wall outlet.



IMPORTANT: Make sure that the AC voltage and polarity appearing at the wall outlet matches the input voltage as well as the polarity marked on the AC adapter.

2.4.2 Definition of Connectors and Jumpers

Table 2.1 Loadcell Connector

Pin	Description	In/Out/Power	Electrical Level
1	+ excitation	power output	5±0.3 VDC (≤0.12A)
2	+ sense	power input	5±0.3 VDC
3	- excitation	power ground	0 VDC
4	- sense	power input	≤0.5 VDC
5	+ signal	signal input	2.5±0.3 VDC
6	- signal	signal input	2.5±0.3 VDC
7	shield	-	-

Table 2.2 Adapter Power Input Connector (ADP)

Pin #	Definition	In/Out/Power	Electrical Level
1	Adapter input voltage +	Power input	9 VDC (6-9VDC, $\geq 0.5A$)
2	Adapter input voltage - (GND)	Power output	0VDC

Table 2.3 Battery Input Power Connector (BAT)

Pin #	Definition	In/Out/Power	Electrical Level
1	Battery input voltage + Power	Input	4-6.8Vdc
2	Battery input voltage - (GND)	Power ground	0Vdc
3	Temperature sensor on Battery input	Power ground	-

Table 2.4 USB Connector for Virtual RS-232 Com1 and Power Supply (J1)

Pin #	Definition	In/Out/Power	Electrical Level
1	VDD	Power output	5 \pm 0.3 VDC
2	RXD Receive on UART1	Input	0-5VDC
3	TXD Transmit on UART1	Output	0-5VDC
4	GND of VDD	Power ground	0VDC
5	GND1 of VUSBH	Power ground	0VDC
6	USB Power DC/DC select	Output	0-5VDC
7	USB Power DC/DC output	output	6 \pm 0.3 VDC

Table 2.5 Serial Input / Output Connector (SIO)

Pin #	Definition	In/Out/Power	Electrical Level
1	RS485 signal A (if RS485 installed)	Input/output	0-5VDC
2	RS232 Transmit on UART0	Output	-12 to +12VDC
3	RS232 Receive on UART0	Input	-12 to +12VDC
4	-	-	-
5	GND	Power ground	0VDC
6	-	-	-
7	-	-	-
8	-	-	-
9	RS485 signal B (if RS485 installed)	Input/output	0-5VDC

Table 2.6 KCAK Jumper Set

Connected Pins	Function
1-2	Calibration enabled
2-3	Calibration disabled

Table 2.7 JP1 Jumper

Connected Pins	Function
1-2	Pins 1-2 are shorted for 4 wire load cell
2-3	Pins 2-3 are shorted for 6 wire load cell

3 Indicator Operation

To set up the indicator, you must first enter the appropriate menu mode. The front panel keys become directional navigators to move around in the menus. See [Table 3.2](#) for details.

3.1 Front Panel

The front panel incorporates the display and keypad.

The annunciators used are incorporated in the display. The annunciator will be lit when the mode is active.

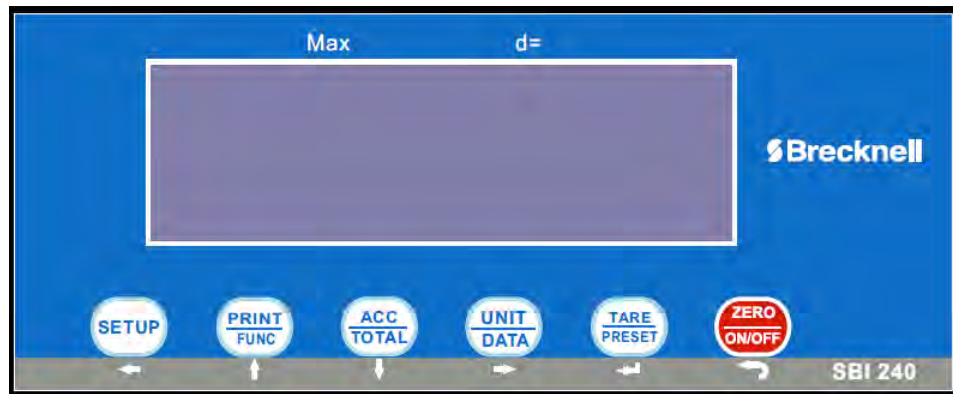

Figure 3.1 Keypad and Display

Table 3.1 LCD Display Annunciators and Definitions

LCD Annunciator	Description
	Better known as the "Center of Zero" annunciator. It is lit when the scale is at the zero point and the gross weight is 0.
	Scale is stable
	Battery level
NET	Indicates net mode and the tare weight is not 0.
Total	Display data is accumulated total times, weight, pieces, or percentage.
Peak	Scale is in dynamic weighing mode. Hold type is PEAK-HOLD.
lb	Indicates the current unit of measure is lb.
oz	Indicates the current unit of measure is oz.
kg	Indicates the current unit of measure is kg.
%	Measure unit is% (in percentage weighing mode).



LCD Annunciator	Description
Pcs	Indicates counting mode. Unit of measure is pieces.
Hold	- Hold flashes - actual fluctuating weight displayed. - Hold does not flash - locked weight is displayed.
HI	Data compare (check-weighing) is enabled. Current data (weight, pieces, or percent) is above the specified upper limit.
OK	Indicates when data compare is enabled and current data (weight, pieces or percent) is between the specified upper and lower limits.
LO	Data compare is enabled. Current data is below the specified lower limit.



When the Model is NTEP certified, some functions will not be enabled and the corresponding annunciator will not be displayed.

3.2 Keys

The keyboard consists of four keys, some of which have multiple functions.

Table 3.2 Function of the Keys

Key	Mode	Condition	Function
	Weigh, count, or percent	Press for less than 3 seconds	Enter or exit HOLD mode
		Press for more than 3 seconds	Enter Setup mode
	Input data mode	Press for more than 3 seconds	Input decimal point
		Press for less than 3 seconds	Return to last sub-menu
Menu selection mode	-	Return to last sub-menu	
	Weigh, count, or percent	Press for less than 3 seconds	Sends output data via the serial port
		Press for more than 3 seconds	Selects mode: Weighing, Counting, or Percent
	Input data mode	-	Increases the digit in the flashing data entry position by one
	Menu selection mode	-	Returns to last item of current sub-menu

Key	Mode	Condition	Function
 	Weigh, count, or percent	Press for less than 3 seconds	Adds accumulation values to memory; displays instances and totals
		Press for more than 3 seconds	Displays accumulation instances and totals
	Input data mode	-	Decreases the digit in the flashing data entry position by 1
	Menu selection mode	-	Goes to next item of current sub-menu
 	Weigh mode	Press for less than 3 seconds	Changes weighing unit of measure
	Count or percent	Press for less than 3 seconds	Enters the sub-menu to input piece weight for counting or to enter reference weight for percent-weighing
	Weigh, count, or percent	Press for more than 3 seconds	Enters the sub-menu to input the comparative data range for check-weighing
	Time and date mode	Press for more than 3 seconds	Enters time or date setting mode
	Input data mode	-	Shifts the flashing data entry position from right to left
	Menu selection mode	-	Advances to next item of current sub-menu
 	Weigh, count, or percent	Press for less than 3 seconds	Tare the weight
		Press for more than 3 seconds	Enters predetermined tare input mode
	Input data mode	-	Confirms the input data and forwards to next step
	Menu selection mode	-	Confirms the input data and forwards to next step
 	Power off mode	-	Power on
	Weigh, count, or percent	Press for less than 3 seconds	Zero function
		Press for more than 3 seconds	Power off
	Input data mode	-	Ignore current operation
	Menu selection mode	-	Exit from current working mode



NOTE: To access the second function of the key, press and hold the key for more than 3 seconds.

3.3 Turn the Indicator ON

Turn on the indicator by pressing the **ZERO/ON/OFF** key.

3.4 Turn the Indicator OFF

Turn the indicator off pressing and holding the **ZERO/ON/OFF** key for 4 seconds.

3.5 Navigating the Weigh Mode

3.5.1 Changing the Working Mode

Press and hold the **[PRINT/FUNC]** key, then use \uparrow \downarrow \leftarrow key to choose and confirm to enter into weighing mode or counting mode.

3.5.2 Normal Weighing Mode

1. Turn on the indicator by pressing the **ZERO/ON/OFF** key.
If the display stabilizes but doesn't show zero, press the **ZERO/ON/OFF** key to set a new zero point.
2. Place objects on the scale platform. The weight will be displayed.



NOTE: Objects should be placed at the center of the platform. Corner or side loading heavy objects may risk overloading an individual load cell and damage the scale.

3. To change the weight unit of measure, press the **UNIT/DATA** key.



NOTE: Under certain conditions, g and lb:oz are not available. In trade applications, lb:oz should be prohibited. Please refer the following tables (3.3 and 3.4)

4. To send data to another device via the serial port, press the **PRINT/FUNC** key.

3.5.3 Zero

If the display does not show \square and there is no weight on the platform, press the **ZERO/ON/OFF** key to zero the reading.

Zero range: $\pm 2\%$ * full Capacity.

The zero function is unavailable when the displayed reading is out of the zero range. The indicator will show one of the following error messages:

\square - - - - Over zero range

0 _ _ _ _ _ Under zero range

3.5.4 Setting a Tare Weight

1. Zero the scale by pressing the **ZERO/ON/OFF** key.
2. Place an empty container on the platform. Press the **TARE/PRESET** key.
The display will return to zero, eliminating the weight of the container. The "NET" annunciator will be lit on the display.
3. Place the material or object to be weighed in the container.
The net weight will be displayed.
4. To exit the tare mode, remove all weight from the scale.
The display will show a negative weight.
5. Press the **TARE/PRESET** key to return the display to zero.

3.5.5 Setting a Pre-determined Tare Weight

1. Zero the scale by pressing the **ZERO/ON/OFF** key.
2. Press and hold the **TARE/PRESET** key until *P r e A r E* is displayed.
The tare weight will be displayed. The first digit and NET will flash on the display.
3. Enter the tare weight using the \uparrow \downarrow \leftarrow keys. After inputting the tare weight, press the **TARE/PRESET** key to confirm.
The "NET" annunciator will be lit in the display.



NOTE: Tare weight must be greater than zero and no more than the maximum scale capacity.

4. Place the material or object to be weighed onto the scale platform.
The net weight will be displayed.
5. To exit tare mode, remove all weight from the scale. The display will show a negative weight. Press the **TARE/PRESET** key to return the display to zero.



NOTE: Note: This indicator can only save one tare weight. The new tare weight will automatically replace the old one. Pre-determined tare will be lost after the scale is turned off.

3.5.6 Change Weight Unit

Press the **[UNIT/DATA]** key to select kg, lb, oz, lb:oz, g. Note: under some conditions oz, lb:oz, g are not available. Please refer the following tables.

Table 3.3 Use kg as Primary Unit

Calibration Division Value	Display Division Value				
	kg	g	lb	oz	lb:oz
0.0001 kg	0.0001 kg	0.1 g	0.0002 lb	0.005 oz	Not available
0.001 kg	0.001 kg	1 g	0.002 lb	0.05 oz	Not available
0.01 kg	0.01 kg	10 g	0.02 lb	0.5 oz	0.5 oz
0.1 kg	0.1 kg	Not available	0.2 lb	5 oz	Not available
1 kg	1 kg	Not available	2 lb	Not available	Not available
10 kg	10 kg	Not available	20 lb	Not available	Not available
0.0002 kg	0.0002 kg	0.2 g	0.0005 lb	0.01 oz	Not available
0.002 kg	0.002 kg	2 g	0.005 lb	0.1 oz	0.1 oz
0.02 kg	0.02 kg	20 g	0.05 lb	1 oz	1 oz
0.2 kg	0.2 kg	Not available	0.5 lb	10 oz	Not available
2 kg	2 kg	Not available	5 lb	Not available	Not available
20 kg	20 kg	Not available	50 lb	Not available	Not available
0.0005 kg	0.0005 kg	0.5 g	0.001 lb	0.02 oz	Not available
0.005 kg	0.005 kg	5 g	0.01 lb	0.2 oz	0.2 oz
0.05 kg	0.05 kg	50 g	0.1 lb	2 oz	2oz
0.5 kg	0.5 kg	Not available	1 lb	Not available	Not available
5 kg	5 kg	Not available	10 lb	Not available	Not available
50 kg	50 kg	Not available	Not available	Not available	Not available

Table 3.4 Use lb as Primary Unit

Calibration Division Value	Display Division Value				
	kg	g	lb	oz	lb:oz
0.0001 lb	Not available	Not available	0.0001lb	0.002 oz	Not available
0.001 lb	0.0005 kg	0.5 g	0.001 lb	0.02 oz	Not available
0.01 lb	0.005 kg	5 g	0.01 lb	0.2 oz	0.2 oz
0.1 lb	0.05 kg	50 g	0.1 lb	2 oz	2 oz
1 lb	0.5 kg	Not available	1 lb	Not available	Not available
10 lb	5 kg	Not available	10 lb	Not available	Not available
0.0002 lb	0.0001 kg	0.1 g	0.0002 lb	0.005 oz	Not available
0.002 lb	0.001 kg	1 g	0.002 lb	0.005 oz	Not available
0.02 lb	0.01 kg	10 g	0.02 lb	0.5 oz	0.5 oz
0.2 lb	0.1 kg	Not available	0.2 lb	5 oz	Not available
2 lb	1 kg	Not available	2 lb	Not available	Not available
20 lb	10 kg	Not available	20 lb	Not available	Not available
0.0005 lb	0.0002 kg	0.2g	0.0005 lb	0.01oz	Not available

Calibration Division Value	Display Division Value				
	kg	g	lb	oz	lb:oz
0.005 lb	0.002 kg	2g	0.005 lb	0.1oz	0.1 oz
0.05 lb	0.02 kg	20g	0.05 lb	1oz	1 oz
0.5 lb	0.2 kg	Not available	0.5 lb	10oz	Not available
5 lb	2 kg	Not available	5 lb	Not available	Not available
50 lb	20 kg	Not available	50 lb	Not available	Not available

3.5.7 Output Data (print to a computer or printer)

When scale is stable press the [PRINT] key.

3.5.8 Display Gross or Net Weight

- If the tare weight is not zero, the Net weight will be displayed.
- If the tare weight is zero, Gross weight will be displayed.

3.5.9 Check Weight (data compare)

The check weighing or data compare function allows the user to enter a pre-set range. The display will indicate whether the weighed value is within that range and indicate if it is too high or too low.

1. Press and hold the **UNIT/DATA** key for 4 seconds to enter the comparative data range.

UNIT or *UNITG* will be displayed first.

2. Use the **UNIT/DATA** keys to select the comparison unit of measure.
3. Press the **TARE/PRESET** key to confirm.

Hi will be shown quickly. The last Hi limit value will be displayed (the default value is 000000). The HI annunciator will be lit on the display.

4. Use the \uparrow \downarrow \leftarrow keys to enter the upper limit of the range.

5. Press the **TARE/PRESET** key to confirm and move to the next step.

Lo will be displayed quickly. The last Lo limit value will be displayed (the default value is 000000). The LO annunciator will be lit on the display.

6. Use the \uparrow \downarrow \leftarrow keys to enter the lower limit of the range.

7. Press the **TARE/PRESET** key to confirm.

8. Press **ZERO/ON/OFF** key to exit and go back to the normal weighing mode.

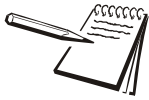

NOTE: If the upper limit is 0, or if it is less than the lower limit, check weighing mode will automatically be exited.

9. After an acceptable range has been set, check weighing may begin.

If the weighed value is within the specified range, $\square \square$ will be displayed on the indicator and an audible beep will sound.

If the value is outside the specified range, $H \square$ or $L \square$ will be displayed with no audible beep.

10. To turn check weighing off, follow the above instructions and change the upper limit to zero.

3.6 Accumulation Mode

The accumulation function allows storage of weighed values and the sums those values. This function can accumulate weights, piece counts, and percentages in normal weighing mode, counting mode, and percent weighing mode.

1. With a load on the scale, press the **ACC/TOTAL** key to add the displayed value to the accumulated total.

The indicator will first display the number of accumulations (e.g. if this is the 5th accumulated value, it will display *ACC.005*).

The accumulated sum total thus far will be displayed and then the load weight will be displayed.



*NOTE: Only loads exceeding the minimum weight (default of 10d, where d = the scale's readability, see specifications) can be accumulated. This setting (*USER - PL d.r PL*) can be modified from its default within User Setup mode, but changes will impact other functions such as HOLD.*

2. Remove the load and place another load to continue accumulating
3. Press and release the **ACC/TOTAL** key to add the new value.



NOTE: To avoid duplicating a value for a same load, the accumulation function requires the original load to be removed before a new value can be accumulated.

4. To view the total accumulated data at any time, press and hold the **ACC/TOTAL** key for 4 seconds.

The number of accumulations and the accumulated sum total will be alternately displayed (weight or quantity) until the **ACC/TOTAL** key is pressed again.

The number of accumulations and total values can be displayed or sent to another device via the serial port by pressing and releasing the **PRINT/FUNC** key.

5. To clear and reset the accumulated data, press and release the **ZERO/ON/OFF** key while total accumulated data and the accumulated sum total are alternatively displayed.



NOTE: When the HOLD function is enabled and working in PEAK HOLD mode, the Accumulation function will automatically be disabled.

3.7 Count Mode

The counting function calculates and displays the piece quantity of the load that has been weighed.

1. From normal weighing mode or percent-weighing mode, press and hold the **PRINT/FUNC** key for 4 seconds.
2. Use the **↑ ↓ ←** keys to select COUNT.
3. Press the **TARE/PRESET** key to confirm and access the counting mode.

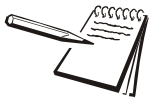

NOTE: In counting mode, the ZERO, TARE, PRINT, HOLD, PRESET TARE, ACC, SETUP, and ON/OFF functions are all available.

There are two ways to enter the piece weight. Find the preferred method and follow the instructions below.

3.7.1 Enter a Known Piece Weight Directly

1. Press the **UNIT/DATA** key.
2. When **INPUT** is displayed, press the **TARE/PRESET** key to access the "Input Piece Weight" mode.



NOTE: At any time you can press ZERO/ON/OFF to exit "Input Piece Weight" and return to counting mode.

3. When *UNIT* is displayed, use the \uparrow \downarrow \leftarrow keys to select the piece weight unit of measure.
4. Press the **TARE/PRESET** key to confirm.

The previously entered piece weight will be shown (the default value is 000000).

5. Use the \uparrow \downarrow \leftarrow keys to input a new piece weight.
6. Press and hold the **SETUP** key for 4 seconds to input the decimal point.
7. Press the **TARE/PRESET** key to confirm and return to counting mode.



NOTE: If the input piece weight is less than 0.5d (where d = the scale's readability, see specifications), the indicator will display PWt.Er and will automatically return to counting mode.

3.7.2 Enter the Piece Weight with a Sample of a Known Quantity

1. Press the **UNIT/DATA** key.
2. When *INPUT* is displayed, use \uparrow \downarrow \leftarrow keys to select *SPL.PWT*.
3. Press the **TARE/PRESET** key to access the "Get Piece Weight" mode.



NOTE: At any time you can press ZERO/ON/OFF to exit "Get Piece Weight" and return to counting mode.

4. When *SPL.L* is displayed, remove any load from the platform and press the **TARE/PRESET** key to confirm.

If the scale hasn't stabilized, *SPL.L* will flash. After it has stabilized, it will go to the next step.

5. When *SPL.H* is displayed, place a sample of a known quantity onto the scale platform and press the **TARE/PRESET** key.

If the scale hasn't stabilized, *SPL.H* will flash.

If the scale has stabilized, *INPUT* will be displayed quickly and the previously entered piece weight will be displayed (the default value is 000000, and the position of decimal point is determined by CONFIG-FUNC-PERCEN setting).

6. Use the \uparrow \downarrow \leftarrow keys to input the sample quantity.

7. Press the **TARE/PRESET** key to confirm.

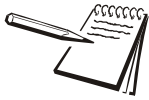

*NOTE: If the input piece weight is less than $0.5d$ (where d = the scale's readability, see specifications), the indicator will display *PWt.Er* and will automatically return to counting mode.*

8. Once an acceptable piece weight has been entered, the scale will return to counting mode.

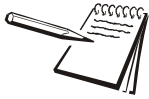

NOTE: The piece weight that has been entered will be saved, even after powering off.

The indicator can only save one piece weight.

Entering a new piece weight will automatically replace the old one.

3.8 Check Counts (count compare) in Counting Mode

The Check Counts function allows the user to enter a pre-set range. The display will indicate whether the weighed value is within that range or indicate if it is too high or too low.

1. Press and hold the **UNIT/DATA** key for 4 seconds to access the comparative data range.
2. HIGH will be shown and *□□□□□□* will be displayed.

The HI annunciator on the display will be lit.

3. Use the \uparrow \downarrow \leftarrow keys to input the upper limit of the range (weight, piece quantity, or percentage depending on initial mode).
4. Press the **TARE/PRESET** key to confirm and move to the next step.
5. Low will be shown and *□□□□□□* will be displayed. The LO annunciator on the display will be lit.
6. Use the \uparrow \downarrow \leftarrow keys to enter the lower limit of the range.
7. Press the **TARE/PRESET** key to confirm.



NOTE: If the upper limit is 0, or if it is less than or equal to the lower limit, check weighing mode will automatically be exited.

8. After an acceptable range has been set, check weighing may begin.

If the weighed value is within the specified range, the OK annunciator on the display will be lit and an audible beep will be sound.

If the value is outside the specified range, the HI or LO annunciator on the display will be lit with no audible beep. Audible beep parameters can be changed from their defaults in User Setup mode.

3.9 Percent Weighing Mode

In this mode, the scale will calculate the weight on the platform and display the percentage after the unit-percentage-weight of goods is obtained.



NOTE: The Percent Weighing Mode is disabled when legal for trade is enabled.



NOTE: If 100% display format is set to 100%, 100.0% or 100.00% in CONFIG-FUNC-PERCEN menu, then the unit-percentage-weight is the weight of 1%, 0.1% or 0.01%.



NOTE: Set CONFIG-FUNC-PERCEN menu to YES for use of the percent weighing function.

1. From the normal weighing or counting mode, press and hold the **PRINT/FUNC** key for 4 seconds,
WEIGH/COUNT will be displayed.
2. Use \uparrow \downarrow \leftarrow key to select PERCEN, then press **TARE/PRESET** to confirm.
Before a new unit-percentage-weight is calculated, the last unit-percentage-weight will be used.

Note: In percent weighing mode, the function of ZERO, TARE, PRINT, HOLD, PRESET TARE, ACC, SETUP, ON/OFF are available.

3.9.1 Using an Entered Weight and Percentage

The scale calculates the unit-percentage-weight.

1. Press the **UNIT/DATA** key, when *UNIT* is displayed.
2. Press the **TARE/PRESET** key to continue.
3. Before entering the weight value, use \uparrow \downarrow \leftarrow key to select the percentage from 1%, 2%, 5%, 10%, 20%, 50% and 100%, corresponding to the weight that will be entered in the following steps.

4. Press the **TARE/PRESET** key to confirm the entry.
5. When *UNIT.WGT* is displayed, use the **UNIT/DATA** key to select the weight unit.
6. Use the **TARE/PRESET** key to continue.
7. Press the **ZERO/ON/OFF** key to exit.
8. When the last stored unit-percentage-weight data is displayed (the default value is 000000), use the \uparrow \downarrow \leftarrow key to enter the new unit-percentage-weight
9. Press the **SETUP** key for more than 4 seconds to enter the decimal point.
10. Press the **TARE/PRESET** key to confirm, save, and to return back to percent weighing mode.

If the calculated unit-percentage-weight is less than 0.5d, the indicator will display *PCEr* and return back to percent weighing mode.

3.9.2 Using Weight Samples when Percentage is Known

1. Press the **UNIT/DATA** key when *PP.PCE* is displayed.
2. Use the \uparrow \downarrow \leftarrow key to select *SPL.PCE*, then press the **TARE/PRESET** key to weigh samples (when the percentage is known), and to calculate the piece weight.
3. Press **ZERO/ON/OFF** key to exit and return to percent weighing mode.
4. When *SPL.L0* is displayed, remove all samples from the scale and press the **TARE/PRESET** key to confirm.
5. Before the scale is stable, *SPL.L0* will flash on the display. When the scale becomes stable, continue to the next step.
6. Press the **ZERO/ON/OFF** key to exit and return to percent weighing mode.
7. When *SPL.H1* is displayed, place samples (when the percentage is known) onto the scale.
8. Press the **TARE/PRESET** key to confirm reading weight. Before the scale is stable, *SPL.H1* will flash on the display. When the scale becomes stable, continue to the next step.
9. Press the **ZERO/ON/OFF** key to exit and return to percent weighing mode.
10. After *PP.PCE* is displayed quickly, the previously entered percent will be displayed. (the default value is 000000, and the position of decimal point is determined by CONFIG-FUNC-PERCEN setting,

11. Use the \uparrow \downarrow \leftarrow key to input the percentage of samples and press the **TARE/PRESET** key to confirm.

If the calculated unit-percentage-weight is less than 0.5d, the indicator will display *P.Lt.Er* and return to percent weighing mode. Otherwise, after the reasonable unit-percentage-weight is calculated, the scale will return to percent weighing mode.

The calculated unit-percentage-weight can be saved when the scale has been powered off and it can be used the next time the scale is powered on.

3.9.3 Check Percent (percentage compare)

The high and low limitation of percentage should be set according to following steps.

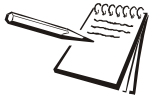

NOTE: Set CONFIG-FUNC-COMPAR menu to YES for use of the percent weighing compare function.

1. In percent weighing mode, press the **UNIT/DATA** key for more than 4 seconds to enter compare data (high and low values).
2. After *HIGH* is displayed, $\square\square\square\square\square\square$ will then be displayed. Use the \uparrow \downarrow \leftarrow key to enter the high percentage number and press the **TARE/PRESET** key to confirm.

The HI annunciator will illuminate.

3. Press the **ZERO/ON/OFF** key to exit and return to percent weighing mode.
4. After *LOW* is displayed quickly, 000000 will then be displayed. Use the \uparrow \downarrow \leftarrow key to enter the low percentage number and press the **TARE/PRESET** key to confirm.

The LO annunciator will illuminate.

5. Press the **ZERO/ON/OFF** key to exit and return to counting mode.

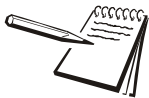

NOTE: If the high number is 0 or is equal or less than low number, the comparison will be disabled.

6. After a reasonable limitation is set and compare is active, one of annunciators HI, OK, LO will be displayed, and the beeper will sound according to the setting in USER-BEEP.

3.10 BMI Working Mode



NOTE: The BMI Working Mode is disabled when legal for trade is enabled.



NOTE: Set CONFIG-FUNC-BMI menu to YES for use of the BMI working mode function.

1. To enter BMI Working mode, CONFIG-FUNC-ACCUMU= Yes:
2. If In normal weighing mode, percent weighing mode, or counting mode, press and hold the **FUNC** key for 4 seconds.

One of the following will be displayed (WEIGH / COUNT / PERCENT) depending on the mode that was set previously.

3. Use the \uparrow \downarrow \leftarrow key to select BMI, then press **TARE/PRESET** to confirm BMI mode.

When the scale enters this mode, " $\square \bar{n} .!!!!$ " (means: last input height is xxx cm) or " $\square \bar{n} .!!!!$ " (means: last input height is xx.x inch) will be displayed, and to wait for input height.

- 3a. To change height unit to cm or inch, press the **UNIT/DATA** key.
- 3b. To change height number, use the \uparrow \downarrow \leftarrow keys.
- 3c. To quickly increase or decrease the number, press and hold **PRINT/FUNC** or **ACC/TOTAL** key.
4. Press the **TARE/PRESET** key to confirm the input.
5. Press the **ZERO/ON/OFF** key to exit input data mode and return to BMI working mode.

The range of height is 50-250cm (19.7-98.4inch) and default is 170cm(66.9inch)

6. In this mode, when BMI number is displayed (BMI annunciate is also lit), or weight number is shown (BMI and kg or lb annunciators are lit), press the **ACC/TOTAL** key to select weight or BMI number to be displayed.
7. When the weight is displayed, the unit can be selected by pressing the **UNIT/DATA** key. The BMI and weight unit will be displayed at same time.
8. In this mode, when current net weight is less than NLD.RNG, the indicator will go to the display weight number if CONFIG-FUNC-ACCUMU= No; or the indicator will return to original working mode if CONFIG-FUNC-ACCUMU= Yes.

3.11 Weight Fine-tune

With this function, the user can adjust the displayed weight (to a minimal extent) with no need for standard weight.



NOTE: The Weight Fine-tune Mode is disabled when legal for trade is enabled.



NOTE: The scale must have been calibrated before this adjustment.





NOTE: The range of adjustment is "(current displayed weight) x (0.9-1.1)". This means the range is about $\pm 10\%$.



NOTE: The "CONFIG-REGULA =NONE" and "CONFIG-FUNC-WT.ADJ=YES" must be set.

1. In normal weighing mode, place a load onto scale. For example 1230.0

The indicator will display the weight (for example 1234.5). Press the **TARE/PRESET** and **ZERO/ON/OFF** keys at same time until first digit flashes, which means indicator has entered into "weight fine-tune" mode.

2. Use the    key to enter the correct weight (the load weight e.g. 1230.0).
3. Confirm by pressing the **TARE/PRESET** key.

The active correct weight will be displayed and the digits will no longer be flashing. The displayed weight will be adjusted by this ratio (1230.0/1234.5) and this ratio will be active until the next modification.

To remove effect of this ratio, follow one of the two options below:

1. Perform standard calibration, refer to the section on "CALIBRATION".
2. Remove weight from the scale and press the **ZERO/ON/OFF** key to display 0.
3. Place a load onto the scale.

A number will be displayed (for example it displayed 1230.0 lb but the original number is 1234.5).

4. Press the **TARE/PRESET** and **ZERO/ON/OFF** at the same time until first digit flashes, which means indicator has entered into "weight fine-tune" mode.

5. Press the **SETUP** key for the displayed weight to be restored to 1234.5, and then press the **TARE/PRESET** key to confirm and exit to normal weighing mode.

3.12 HOLD Function

HOLD function can be used to freeze the display number. In this mode, the scale can catch a dynamic number, hold a stable number, or average an unstable number and HOLD (freeze) this number temporary for the user to watch or record.

In Positive or Negative Peak HOLD mode, the PEAK and HOLD annunciator will be lit, and for other HOLD modes, the HOLD annunciator will be lit. When HOLD annunciator is flashing, the displayed number is live. When HOLD annunciator becomes steady, the displayed number is frozen.

This function can be used in normal weighing mode, counting mode and percent weighing mode. After entering HOLD mode, the A/D converter speed can be increased to 80Hz (if USER-HOLD-AD.H.SPD is set to YES) from the original 10Hz for some dynamic weighing applications.

With the HOLD function, it is possible to weigh restless weighing samples such as live animals or moving objects. The indicator provides a special mode setting to accommodate movement in weight.



NOTE: The Hold Function is disabled when legal for trade is enabled.

1. For the HOLD function to be active, the CONFIG-FUNC-HOLD menu item must be set to YES. Menu items of USER-HOLD-HLD.MOD /-AVG.TIM /-HLD.TIM /-STB.TIM, USER-OTHER-NLD.RNG need be set to reasonable values.
2. To increase the speed for sampling of weight, set USER-HOLD-AD.H.SPD menu item to YES.
3. To enter HOLD working mode, press the **SETUP** key when scale is in normal weighing mode, counting mode or percent weighing mode.

There are several HOLD modes use to freeze display data:

- Positive Peak Number HOLD mode
- Negative Peak Number HOLD mode
- Toggle HOLD mode
- Average HOLD mode
- Auto HOLD mode

Refer to the following sections for information on the available HOLD modes.

3.12.1 Positive Peak HOLD

When USER-HOLD-HLD.MOD is set to PS.PEAK, the hold mode is positive peak hold mode. When the scale first enters this working mode, it will display the largest positive number that is from the time of zero-point set.

After entering this working mode, the scale will always capture and refresh with the largest positive number. To exit the HOLD mode, press the **SETUP** key.

3.12.2 Negative Peak HOLD

When USER-HOLD-HLD.MOD is set to NG.PEAK, the hold mode is negative peak hold mode. When the scale first enters this working mode, it will display the largest negative number that is from the time of zero-point set.

After entering this working mode, the scale will always capture and refresh with the largest negative number. To exit HOLD mode, press the **SETUP** key.

3.12.3 Toggle HOLD

When USER-HOLD-HLD.MOD is set to TOGGLE, the hold mode is toggle in hold mode. After entering this working mode, the scale will freeze and display the number if the scale is stable. Only the weight that is over USER-OTHER-NLD.RNG (zero 'dead' band) can be held.

To exit HOLD mode, press the **SETUP** key. If the length of time that the scale is unstable for more than USER-HOLD-STB.TIM, *Stb.Er* will be displayed. Press the **TARE/PRESET** key to start averaging again, or press the **SETUP** key to exit.

3.12.4 Average HOLD

When USER-HOLD-HLD.MOD is set to AVERAG, the hold mode is average hold mode. After entering this working mode, the scale will freeze and display number if the scale is stable. If the scale is not stable, but the variation is less than USER-HOLD-HLD.RNG, the scale will average data in USER-HOLD-AVG.TIM, then freeze and display the number. Only the weight that is over USER-OTHER-NLD.RNG can be frozen. Scale will exit HOLD mode according to the setting of USER-HOLD-HLD.TIM. If the time of scale variation is over USER-OTHER-NLD.RNG or is more than USER-HOLD-STB.TIM, *Stb.Er* will be displayed. Press **TARE/PRESET**, **UNIT/DATA**, **ACC/TOTAL** or **PRINT/FUNC** to start averaging again, or press **SETUP** key to exit.

3.12.5 Auto HOLD (default setting)

When USER-HOLD-HLD.MOD is set to AUTO, the hold mode is auto hold mode. Different subjects can be weighed one after another without pressing any buttons. After entering this working mode, the scale will freeze and display the number if the scale is stable. If the scale is not stable, but the variation is less than USER-HOLD-HLD.RNG, the scale will average data in USER-HOLD-AVG.TIM, then freeze and display the number. Only the weight that is over USER-OTHER-NLD.RNG can be frozen. If the held weight is removed, and a new load is placed on the scale, the scale will automatically hold the new number of the load.

The scale will exit HOLD mode according to the setting of USER-HOLD-HLD.TIM. If the time of scale variation is over USER-OTHER-NLD.RNG or is more than USER-HOLD-STB.TIM, *Stb.Er* will be displayed. Press the **TARE/PRESET** key to start averaging again, or press **SETUP** key to exit.

4 Setup Mode

The setup menu consists of five different sub-menus. Within each sub-menu are different menu options.

The config/cal switch must be set in the ON position in order to make changes to specific parameters.

4.1 Entering the Setup Menu





1. Power on the indicator by pressing and holding the **ZERO/ON/OFF/** key.
2. Press the **SETUP** key for 3 seconds. The indicator shows $[CONF]$ to indicate the Setup Menu mode has been entered.
3. In the Setup mode, use the arrow keys to select a menu item. Press the **TARE/PRESET** key to enter the parameter.
4. Press the \uparrow \downarrow \leftarrow key to select the sub-menu item, to select a choice, to set a number, to confirm and save data, and/or to exit this mode.

4.2 Navigating the Setup Menu



1. Once $[CONF]$ is displayed, use the **[UNIT]** key to move forward through the menu choices or the **[HOLD]** key to move backward in the setup menu.
2. Use the **[TARE]** key to access the desired menu. (e.g. $USER$)
3. Use the **[UNIT]** key to view the available sub-menus (parameter: e.g. $beEP$).
4. Use the **[TARE]** key to select the sub-menu.
5. Use the **[UNIT]** key to view the choices within the sub-menu. (e.g. EEY)
6. Press the **[TARE]** key to select the desired choice within the sub-menu. Once selected the parameter will be displayed.
7. Press **[ZERO]** to return back up and return to the setup menu.

Table 4.1 Key Navigation

<p>[SETUP]</p> 	<p>Access the Setup Menu</p> <p>Returns to last sub-menu</p>
<p>[PRINT / FUNC]</p> 	<p>Scroll through available menus</p> <p>Return to last item of current sub-menu</p>
<p>[ACC / TOTAL]</p> 	<p>Advance to next item of current sub-menu</p>
<p>[UNIT / DATA]</p> 	<p>Advance to next item of current sub-menu</p>
<p>[TARE / PRESET]</p> 	<p>Confirm data input and advances to the next step</p>

4.3 Setup Menu Parameters

This section provides more detailed descriptions of the selections found in the Setup Menu.

The menu charts show the flow of the parameters and also provide a quick reference to the parameters within the menu.

The menu tables show the sub-menus, options and default parameter in LCD display format to coincide with the actual display.

4.3.1 CONFG Menu

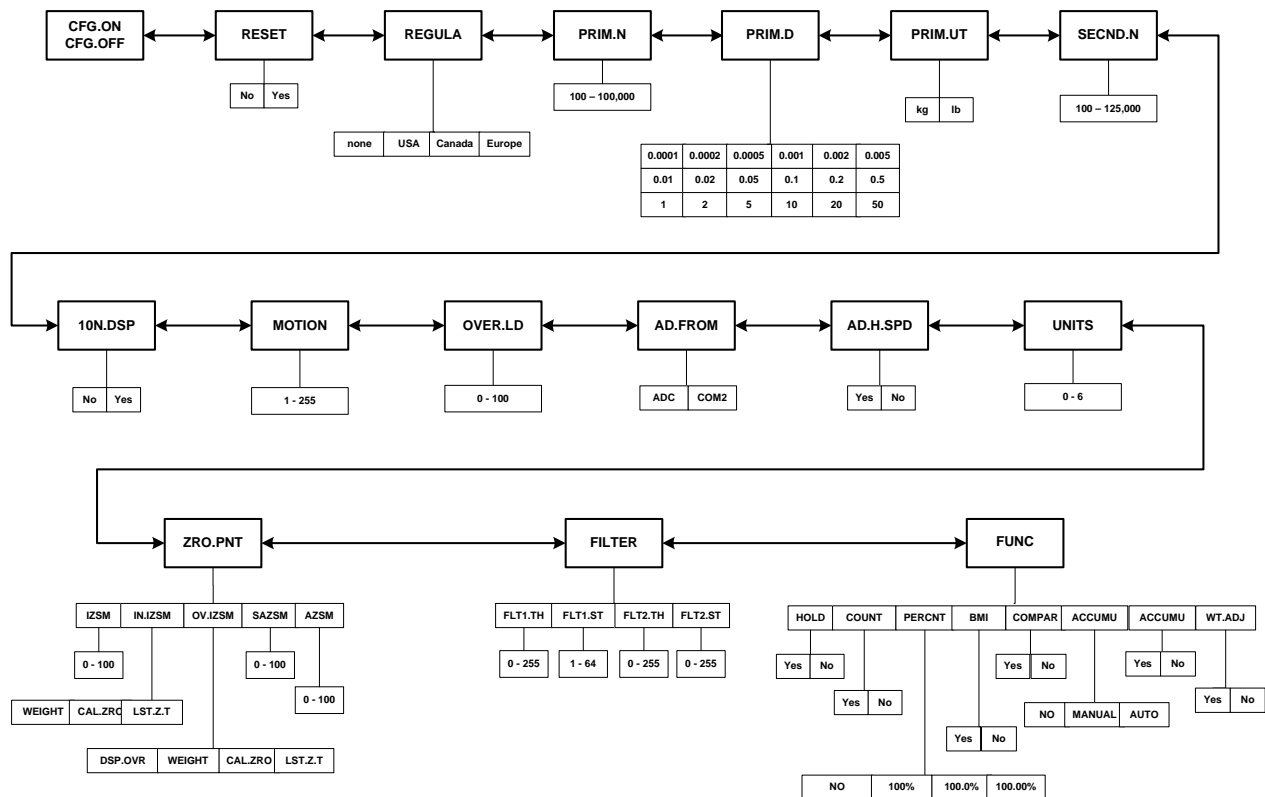

Figure 4.1 CONFG Menu Chart

The figure above is an illustration of the available menus with the CONFG menu and the choices within those menus. Refer to Table 4.2 for explanations of the menu choices.

Table 4.2 CONFG Menu Choices and Explanations

CONFG					
SubMenu1	SubMenu2	Option	Default	Parameter Description	Comment
CFG.ON CFG.OFF			ON	Seal switch position	The display will show whether the seal switch is in the ON or Off position. This parameter can't be changed within the software.
RESET		NO YES	NO	Reset Config menu parameters to default setting	
REGULA		NONE USA CANADA EUROPE		Select the standard in which the scale will comply: USA, Canada, Europe	*None = not legal for trade.

CONFIG					
SubMenu1	SubMenu2	Option	Default	Parameter Description	Comment
PRIM.N		100 - 100000		Primary full scale value	Default full scale value will depend on capacity of scale. *If (REGULA) ≠ none, the max is 10,000
PRIM.d		0.0001		The division value under primary unit	Default division size will depend on capacity of scale. The division value under second unit is automatically determined by the indicator according to the division value under primary unit.
		0.0002			
		0.0005			
		0.001			
		0.002			
		0.005			
		0.01			
		0.02			
		0.05			
		0.1			
		0.2			
		0.5			
		1			
		2			
		5			
10					
20					
50					
PRIM.Ut		KG		Primary u	Select the primary unit from kg or lb. The second unit is lb if kg is selected as the primary unit. *The calibration standard weight must be in the primary unit!
		Lb			
SECONd.N		100- 125000		Second scale full scale value	The division number under second unit. The maximum is 1.25*(PRIM.N). *If (REGULA)≠none, the max is 10,000 NOTE: Secondary division has to match the primary division.

CONFIG					
SubMenu1	SubMenu2	Option	Default	Parameter Description	Comment
10.0.d5P		None	None	Display weight at 10 times division number under primary unit	*If (REGULA)= none this parameter will not be available. When yes is selected, some menus will not be active.
		YES			
not ion		1-255	4	Motion window	1-255 = $\pm 0.25d \cdot (1-255)$ *If (REGULA)=none, the max is 12
o5Er.Ld		0- 100	0	Overload display limitation	0=FS+9d 1-100=101%FS -200%FS. *If (REGULA)=none, the max is 10
AdFrom		ADC	ADC	Where the A/D data comes from	ADC =local A/D chip on PCB COM3 =COM3 interface
		COM3			
AdH5Pd		None	None	Speed of A/D conversion	NO =10Hz; YES =80Hz; if AD.FROM=COM3,this item will not be shown
		YES			
UNITS	KG	YES	YES	UNITS key	YES = enable this unit No = disable this unit In trade applications, lb:oz is not allowed
		None			
	Lb	YES	YES		
		None			
	oz	YES	None		
		None			
	Lb:oz	YES	None		
		None			
G	YES	YES			
	None				

CONFIG					
SubMenu1	SubMenu2	Option	Default	Parameter Description	Comment
Zero Point	Initial	0-100	10	Initial zero set mechanism	Range of capacity in percent ± 0 - 100%FS Also uses SAZSM and AZSM (total) *If (REGULA)=none, the max is 10
		WEIGHT	CAL.ZR0	Inside IZSM	WEIGHT= on power up
					CAL.ZR= calibration zero point
	LAST.ZT			LST.Z.T=store last push button zero and push button tare *If (REGULA) ≠none, the value is fixed on WEIGHT	
				DP.OVR	Outside IZSM
	WEIGHT= current weight Can zero more weight (approx 90%) before dashes are displayed. Not Legal for Trade				
	CAL.ZR0	CAL.ZR= calibration zero point will display dashes at 100%			
	LAST.ZT	LST.Z.T=Last ZERO and TARE			
	Zero Key Range	0-100	2	Zero key range	0=no limitation 1-100= (initial zero point) ±1%FS - (initial zero point) ±100%FS *If (REGULA) ≠none, the max is 2
		Zero Tracking Window	0-100	8	Zero tracking window
Filter	FL1 TH	0-255	40	Digital filter1 threshold	0=no filter1 1-254=filter1 used only when vibration in ±0.25d*(1-254) 255= filter1 always used
	FL1 INT	1-64	8	Digital filter1 intensity	1-64 A/D data will be averaged
	FL2 TH	0-255	8	Digital filter2 threshold	0=no filter2 1-254=filter2 used only when vibration in ±0.25d*(1-254) 255= filter2 always used
	FL2 INT	0-255	240	Digital filter2 intensity	0-255=weak to strong

CONFIG					
SubMenu1	SubMenu2	Option	Default	Parameter Description	Comment
FUNC	HoLd	YES	No	Enable or disable hold function	YES NO
		No			
	CoUNT	YES	No	Enable or disable counting function	YES NO
		No			
	PERCENT	YES	No	Enable or disable percentage weighing function	NO=disable 100% =enable and display format is 100% 100.0% =enable and display format is 100.0% 100.00% =enable and display format is 100.00%
		No			
	bmi	YES	No	Enable or disable the BMI function	YES NO
		No			

***The setting will be limited by the choice of REGULA**

4.3.2 USER Menu

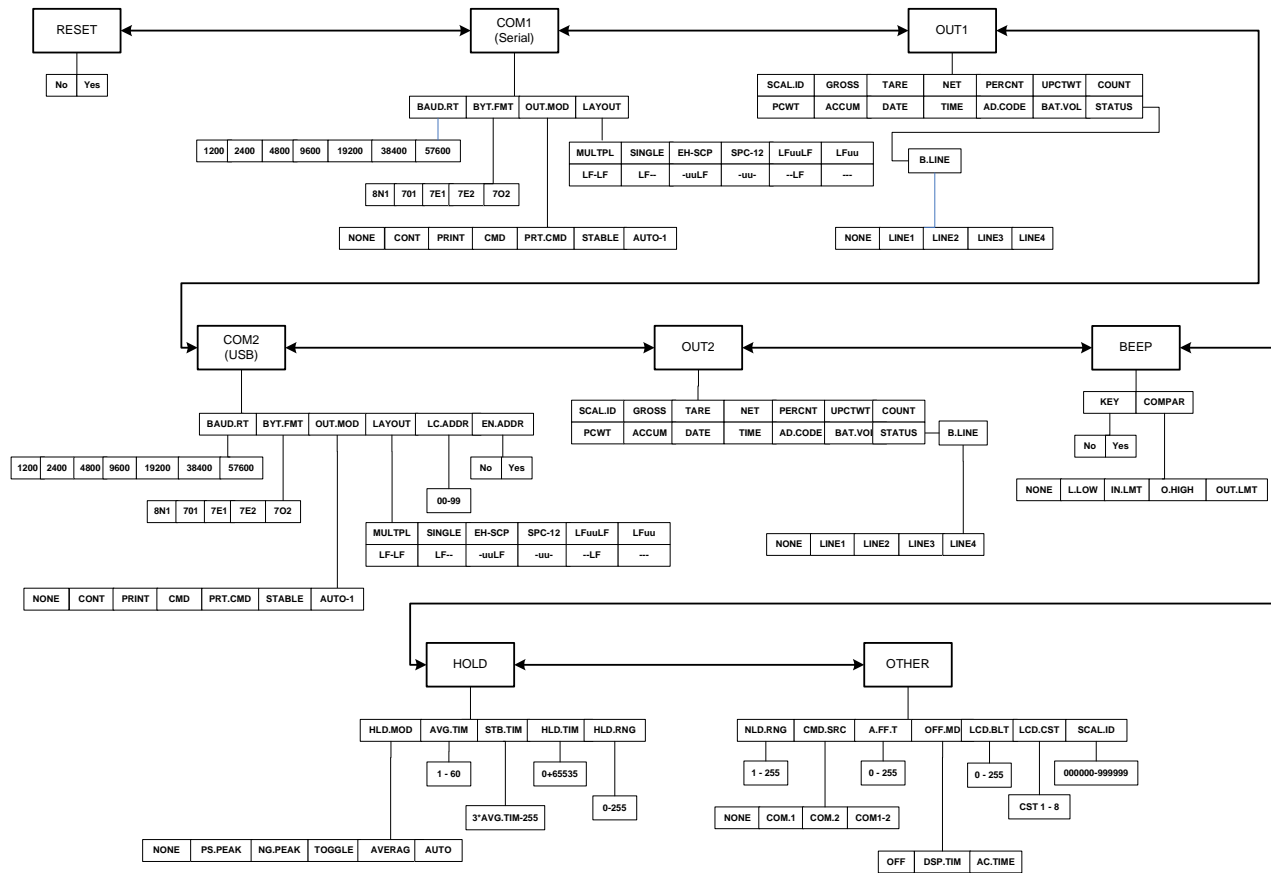

Figure 4.2 USER Menu Chart

The figure above is an illustration of the available menus with the USER menu and the choices within those menus. Refer to [Table 4.3](#) for explanations of the menu choices.

Table 4.3 User Menu Choices and Explanations

USER					
SubMenu1	SubMenu2	Option	Default	Parameter Description	Comment
rESEt		no	no	Reset User menu parameters to default setting	
		YES			
COM1 (Serial)	bAUDrE	1200	9600	Select COM1 baud rate	
		2400			
		4800			
		9600			
		19200			
		38400			
	bYt.FnE	8N1	7E1	Select COM1 byte format	(1) 8N1=8 data bits, No parity check bit, 1 stop bit
		7O1			(2) 7O1=7 data bits, 1 Odd parity check bit, 1 stop bit
		7E1			(3) 7E1=7 data bits, 1 Even parity check bit, 1 stop bit
		7O2			(4) 7O2=7 data bits, 1 Odd parity check bit, 2 stop bit
		7E2			(5) 7 data bits, 1 Even parity check bit, 2 stop bit
	oUt.mOd	noNE	PrE.CnD	Select COM1 output mode s	(1) NONE= no communication
		CoNt			(2) CONT= continuously output
		Pr,nt			(3) PRINT= output after [PRINT] key is pressed
		CnD			(4) CMD= output after a request command is received
		PrE.CnD			(5) PRT.CMD= output after [PRINT] key is pressed or request command received
		StABLE			(6) STABL= sends output automatically after scale is stable. Note: use PRINT or CMD to output data, the scale must be stable
AUtO-1		(7) AUTO-1= when weight is removed			

**Note: If PRINT, STABL, or CMD are used to output data, the scale must be stable.

USER						
SubMenu1	SubMenu2	Option	Default	Parameter Description	Comment	
	LAYoUt	̄ULtPL	̄ULtPL	Set COM1 content and format	(1) MULTI= the following selected item in OUT1 will be output use defined format	
		S,NGLE		Emulates NCI-SCP01 protocol	(2) SINGLE= only displayed content and current status will be output, it's compatible with NCI-SCP01	
		EH-SP2		EH-SP2: command response mode (PS60 UPS)		
		EH-SCP (EH-SP1)		Emulates Toledo PS60/8215	(3) EH-SCP (EH-SP1)= command response mode (PS-60)	
		SCP 12		Emulates NCI 3835	(4) SCP12= only displayed content and current status will be output.	
		LFUUULF		Output Print Formats (refer to section 6.4 for details)	<LF>WWW.WWuu<CR><LF>	
		LFUU--			<LF>WWW.WWuu<CR>	
		LF--LF			<LF>WWW.WW<CR><LF>	
		LF----			<LF>WWW>WW<CR>	
		--UULF			WWW.WWuu<CR><LF>	
		--UU--			WWW.WWuu<CR>	
		----LF			WWW.WW<CR><LF>	
		-----			WWW.WW<CR>	
		oUt 1	SCAL.id		YE5 No	No
	Gross	YE5 No	No		Enable or disable gross weight	Prompt is "GROSS"
	tArE	YE5 No	No	Enable or disable tare weight	Prompt is "TARE"	
	NEt	YE5 No	YE5	Enable or disable net weight	Prompt is "NET"	
	PERCt	YE5 No	No	Enable or disable output weight percentage	Prompt is "PERCENTAGE"	

USER					
SubMenu1	SubMenu2	Option	Default	Parameter Description	Comment
00E1	UPCEYE	YES	No	Enable or disable output weight of 1% percentage	Prompt is "1% REF WT"
		No			
	COUPE	YES	No	Enable or disable counts	Prompt is "QUANTITY"
		No			
	PCYE	YES	No	Enable or disable piece weight	Prompt is "PIECE WT"
		No			
	bñi	YES	No	Enable or disable output height and BMI	Prompt is "HEIGHT" and "BMI"
		No			
	ACCUNU	YES	No	Enable or disable output accumulation times and total	Prompt is "ACC. N" and "TOTAL"
		No			
	dAEE	YES	No	Enable or disable output date	Prompt is "DATE"
		No			
	E,ñE	YES	No	Enable or disable output time	Prompt is "TIME"
		No			
	Ad.CodE	YES	No	Enable or disable ADC code	Prompt is "A/D CODE"
		No			
	bAŁ.ŁoL	YES	No	Enable or disable whether to display the battery voltage	Prompt is "VOLTAGE"
		No			
	ŁAŁUŁ	YES	No	Enable or disable scale status	Prompt is "STATUS"
		No			
b.L,ñE	NoñE	L,ñE1	How many blank lines after strings output	NONE= no blank line LINE1/2/3/4=there are 1, 2,3 or 4 blank lines after strings, used for paper feed forward 1/2/3/4 lines.	
	L,ñE1				
	L,ñE2				
	L,ñE3				
	L,ñE4				

USER					
SubMenu1	SubMenu2	Option	Default	Parameter Description	Comment
COM2 (USB)	bAUDrE	1200	9600	Select COM2 baud rate	
		2400			
		4800			
		9600			
		19200			
		38400			
	bYTE.FnE	8N1	7E1	Select COM2 byte format	(1) 8N1=8 data bits, No parity check bit, 1 stop bit
		7O1			(2) 7O1=7 data bits, 1 Odd parity check bit, 1 stop bit
		7E1			(3) 7E1=7 data bits, 1 Even parity check bit, 1 stop bit
		7O2			(4) 7O2=7 data bits, 1 Odd parity check bit, 1 stop bit
		7E2			(5) 7E2=7 data bits, 1 Even parity check bit, 2 stop bit
	oUte.nE	NONE	PrE.CNd	Select COM2 output mode	(1) NONE= no communication
		CONt			(2) CONT= continuously output
		Pr,nt			(3) PRINT= output after PRINT key pressed
		CnE			(4) CMD= output after a request command is received
		PrE.CNd			(5) Prt.CD= output after PRINT key pressed or request command received
		StAbLE			(6) STABL= output after scale is stable; Note: use PRINT or CMD to output data, the scale must be stable

**Note: If PRINT, STABL or CMD are used to output data, the scale must be stable.

USER					
SubMenu1	SubMenu2	Option	Default	Parameter Description	Comment
	L9OUT	MULTI	MULTI	Set COM2 content and format	(1) MULTI= the following selected item in OUT2 will be output use defined format
		SINGLE		Emulates NCI protocol	(2) SCP01= only displayed content and current status will be output, it's compatible with NCI-SCP01
		EH-SCP (EH-SP1)		Emulates Toledo PS60	(3) EH-SCP (EH-SP1)= command response mode (PS-60)
		SCP12		Emulates NCI3835	(4) IBM= only displayed content and current status will be output. Compatible with NCI-SCP12
		EH-SP2		EH-SP2: command response mode (PS60 UPS)	
		LFUULF		Output Print Formats (refer to section 6.4 for details)	<LF>WWW.WWuu<CR><LF>
		LFUU--			<LF>WWW.WWuu<CR>
		LF--LF			<LF>WWW.WW<CR><LF>
		LF----			<LF>WWW>WW<CR>
		--UULF			WWW.WWuu<CR><LF>
		--UU--			WWW.WWuu<CR>
		----LF			WWW.WW<CR><LF>
		-----			WWW.WW<CR>

USER					
SubMenu1	SubMenu2	Option	Default	Parameter Description	Comment
ዕሀቲፖ (USB)	ኔርሊ.ሳ	ሃይ	በዐ	Enable or disable scale ID number	Prompt is "SCALE ID"
		በዐ			
	ፍሮሳይ	ሃይ	በዐ	Enable or disable gross weight	Prompt is "GROSS"
		በዐ			
	ቲላይ	ሃይ	በዐ	Enable or disable tare weight	Prompt is "TARE"
		በዐ			
	ቢይ	ሃይ	ሃይ	Enable or disable net weight	Prompt is "NET"
		በዐ			
	ፑሮሰንቲ	ሃይ	በዐ	Enable or disable weight percentage output	Prompt is "PERCENTAGE"
		በዐ			
	ሀፐርሲፕ	ሃይ	በዐ	Enable or disable weight of 1% percentage output	Prompt is "1% REF WT"
		በዐ			
	ርዕሳይ	ሃይ	በዐ	Enable or disable counts	Prompt is "QUANTITY"
		በዐ			
	ፑሲ	ሃይ	በዐ	Enable or disable piece weight	Prompt is "PIECE WT"
		በዐ			
	ከን፣	ሃይ	በዐ	Enable or disable height and BMI output	Prompt is "HEIGHT" and "BMI"
		በዐ			
	ላርሲዮን	ሃይ	በዐ	Enable or disable accumulation times and total output	Prompt is "ACC. N" and "TOTAL"
		በዐ			
ደላይ	ሃይ	በዐ	Enable or disable date output	Prompt is "DATE"	
	በዐ				

USER					
SubMenu1	SubMenu2	Option	Default	Parameter Description	Comment
	t, nE	YES	No	Enable or disable time output	Prompt is "TIME"
		No			
	AdCodE	YES	No	Enable or disable ADC code	Prompt is "A/D CODE"
		No			
	bE.VoL	YES	No	Enable or disable whether to display the battery voltage	Prompt is "VOLTAGE"
		No			
	StAuS	YES	No	Enable or disable scale status	Prompt is "STATUS"
		No			
	b.L, nE	NoNE	L, nE 1	How many blank lines after strings output	NONE= no blank line LINE1/2/3/4=there are 1, 2,3 or 4 blank lines after strings, used for paper feed forward 1/2/3/4 lines.
		L, nE 1			
		L, nE 2			
		L, nE 3			
		L, nE 4			
	bEEP	EEY	YES	YES	Enable or disable beep after a key is pressed.
No					
Co nPAR		NoNE	, n.L nE		(1) NONE = no beep
		L.LoY			(2) L.Low = beep when lower than low limitation;
		, n.L nE			(3) IN.LMT = beep when in range of low and high limitation
		o.H, GH			(4) O.HIGH = beep when over high limitation
		oUt.L nE			(5) OUT.LMT = beep when lower than low limitation or higher than high limitation

USER					
SubMenu1	SubMenu2	Option	Default	Parameter Description	Comment
HoLd	Ad.H.SP	YES	No	Enable or disable use of the high speed A/D converter after entering the HOLD mode	
		No			
	HLd.n̄d	None	Auto	Hold mode	(1) NONE= off
		PS.PEAK			(2) PS.PEK= Positive Peak number Hold mode. Scale will display and refresh the positive peak value from last zero setting.
		NG.PEAK			(3) NG.PEK= Negative PEAK number Hold mode. It is similar to PS.PEK, but a negative number is used.
		TOGGLE			(4) TOGGLE= Press [HOLD] key to enter HOLD mode. Stores the display value. Will stay on the display for the duration of time set at HLD.TM.
		AVERAG			(5) AVERG= Average HOLD mode. Time it looks at the weight before updating the display. Set by AVG.TM. Weight or vibration must fall within window of HLD.RG also.
		AUTO			(6) AUTO= Auto hold mode. It is similar to AVERAG mode, but will allow more weight to be added.
	Avg.t̄m̄	1-60	3	Average data time for HOLD mode	1-60 seconds
	Stb.t̄m̄	311Avg.t̄m̄ - 255	9	Wait time for the scale to be stable in HOLD mode	Window which has to be 3 times larger than AVG.TM
	HLD.t̄m̄	0-65535	0	Data HOLD time	0=data will be frozen until HOLD key pressed. 1-65535=data frozen time is 1-65535s, after the time elapses, scale will exit HOLD mode.
HLD.r̄ng	0-255	5	Hold range	Window of vibration for Auto to work. 0=any data can be averaged 1-255= only the data which vibration is in 1-255d can be averaged and held.	

USER					
SubMenu1	SubMenu2	Option	Default	Parameter Description	Comment
<i>oLHEr</i>	<i>PLdrNG</i>	<i>1-255</i>	<i>10</i>	No hold range	Load must return to zero in divisions to perform a print when in AUTO. 1-255=the range of weight is 1-255d. When current weight is less than this value, the scale can be regarded as empty, or the load on scale is removed. It must be bigger than (CONFIG.MOTON).
	<i>Cñd.brC</i>	<i>None</i>	<i>Cñ 1,2</i>	Command source Turns COM1 / COM2 on/off	NONE =no any command will be executed COM.1 = command from COM1 will be executed COM.2 = command from COM2 will be executed COM.1.2 = command from COM1 or COM2 will be executed
		<i>Cñ.1</i>			
		<i>Cñ.2</i>			
		<i>Cñ 1,2</i>			
	<i>R.oFFt</i>	<i>0-255</i>	<i>5</i>	Auto off time	0 =not auto power off 1-255 =auto power off after 1-255 minutes. In this period, no operation or no weight change
	<i>oFF.ñd</i>	<i>oFF</i>	<i>oFF</i>	Auto off mode	OFF =turn off instrument; DSP.TIM = display time; AC.TIME =turn off when only battery is used, display time when AC adaptor is used? If set to DSP.TM or AC.TIME, will continuously output "time".
		<i>dSPt iñ</i>			
		<i>ACt iñE</i>			
	<i>LCd.bLt</i>	<i>0-255</i>	<i>30</i>	LCD backlight set	0 =always off 1 =always on 2 =press down ZERO+UNIT together more than 3s to turn on or turn off 3-255 =auto on when key operation or weight changing. Auto off after 3-255s elapsed.
	<i>LCd.CSt</i>	<i>CSt 1-8</i>	<i>CSt 8</i>	LCD contraction level selection	
	<i>ScAL.iD</i>	<i>000000-999999</i>	<i>123456</i>	Scale ID number	000000-999999

4.3.3 CAL Menu

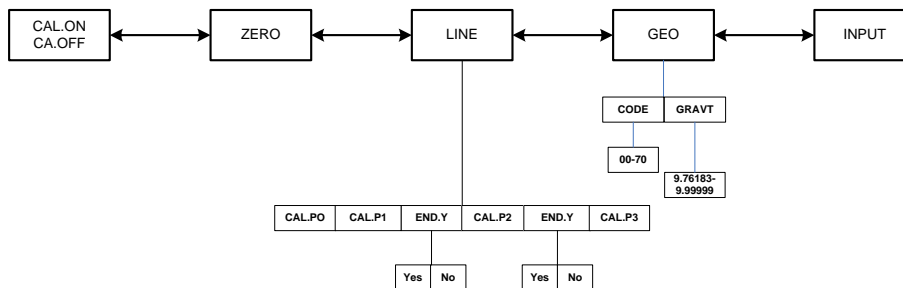

Figure 4.3 CAL Menu Chart

The figure above is an illustration of the available menus with the CAL menu and the choices within those menus. Refer to [Table 4.4](#) for explanations of the menu choices.

Table 4.4 CAL Menu Choices and Explanations

CAL				
Submenu1	Submenu2	Option	Parameter Description	Comment
<i>CAL.ON</i> <i>CA.OFF</i>			Seal switch position	The display will show whether the seal switch is in the ON or Off position. This parameter can't be changed within the software.
<i>Zero</i>			Zero point calibration	Only do zero point calibration, then go to CAL.END to end (only need where a zero shift has occurred).

CAL					
Submenu1	Submenu2	Option	Parameter Description	Comment	
<i>L I N E</i>	<i>CAL.P0</i>		Line calibration point0	Do zero point calibration. This point can't be omitted.	
	<i>CAL.P1</i>		Line calibration point1	First weight point calibration. This point can't be omitted and standard weight must be over 10%FS.	
	<i>E N D Y</i>	<i>Y E S</i>	End calibration?		YES=go to CAL.END to end NO=go to do next point calibration
		<i>NO</i>			
	<i>CAL.P2</i>		Line calibration point2	Second weight point calibration. Standard weight must be over 10%FS and be larger than it in CAL.P1. This point can be omitted.	
	<i>E N D Y</i>	<i>Y E S</i>	End calibration?		YES=go to CAL.END to end NO=go to do next point calibration
		<i>NO</i>			
<i>CAL.P3</i>		Line calibration point3:	Third weight point calibration. Standard weight must be over 10%FS and be larger than it in CAL.P2, this point can be omitted.		
<i>G E O</i>	<i>C o d E</i>	<i>00-70</i>	Select geographical position	Code 00-70	
	<i>G r A v i t y</i>	<i>9.76 183-9.99999</i>	Input gravity of user location		
<i>I N P U T</i>			Input or view calibration parameter values	Only used to copy calibration parameters from one scale to a new scale.	
<i>C A L E N D</i>			Calibration end and restart		

4.3.4 MISC Menu



Figure 4.4 MISC Menu Chart

The figure above is an illustration of the available menus with the MISC menu. There are no programming choices within this menu. Refer to [Table 4.5](#) for explanations of the menu choices.

Table 4.5 MISC Menu Choices and Explanations

MISC	
Submenu1	Remark
<i>CodE</i>	Display A/D counts = approximately 100,000 counts per mV
<i>ūoL</i>	Display voltage; calibrate voltage; set full charged voltage and low battery voltage
<i>dAtE</i>	Display date and set date.
<i>t, nE</i>	Display time and set time.
<i>ūEr</i>	Display firmware version

4.3.5 TEST Menu

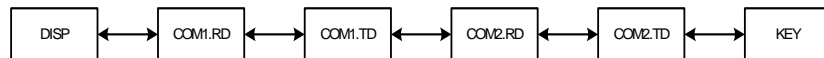

Figure 4.5 TEST Menu Chart

The figure above is an illustration of the available menus with the TEST menu. There are no programming choices within this menu. Refer to [Table 4.6](#) for explanations of the menu choices.

Table 4.6 TEST Menu Choices and Explanations

TEST	
Submenu1	Remark
<i>dSP.tS</i>	Test LCD
<i>Cñ lrd</i>	Test COM1 receiving
<i>Cñ l.td</i>	Test COM1 transmitting
<i>Cñ2.rd</i>	Test COM2 receiving
<i>Cñ2.td</i>	Test COM2 transmitting
<i>KEY.tS</i>	Test keys and buzzer

4.4 Exit the Setup Menu

1. Power off the indicator by pressing and holding the **[ON/OFF]** key.
2. Turn the indicator back on by pressing the **[ON/OFF]** key. The display will go through a digit check, then settle into the normal operating mode. All front panel keys will now return to their normal mode of operation.

5 Calibration

The configuration/calibration button must be pushed in order to calibrate the scale.



NOTE: More than 10% of the full scale weight is needed for calibration.



NOTE: In the following steps, pressing ZERO/ON/OFF will show "E//, L?", and pressing ZERO/ON/OFF again or pressing TARE/PRESET will exit the calibration.

5.1 Enter the Calibration Mode

1. Access the setup mode by pressing the **[HOLD]+[ON/OFF]** key for 3 seconds.
2. Use the **[PRINT]** key to select the CAL menu.
3. Press the **[TARE/PRESET]** key to enter the calibration mode.
- 3a. After entering this mode, the number of calibrations will be shown first. This number will be increment one digit after every calibration and calibration data saved. This counter can't be modified or erased. It counts from 0000 to 9999, when 9999 is reached, the counter starts over at 0000.
4. After the counter number was displayed, it will show "**CAL.OFF**" or "**CAL.ON**" which depends on whether the sealed calibration switch is OFF or ON. **If the switch is OFF, the following steps can be done, but the result will not be saved.**
5. Press the **[TARE]** key to go to next step.
6. When **E r o** is display, use **↑ ↓ ←** key to select ZERO to perform zero point calibration (refer to step 4), LINE to perform linearity calibration (refer to step 5), GEO to do Geographical calibration (refer to step 6) or INPUT to Input view calibration parameters value (refer to step 7).

5.2 ZERO Calibration

When ZERO is selected, remove all weight from the scale and press the **TARE/PRESET** key to confirm.

The ZERO will flash when it is in the catching zero point state. After receiving reasonable data, it will automatically continue to step 8.

5.3 Linearity Calibration

1. When *L i n E* is selected, press the **TARE/PRESET** key to access linearity calibration.
0% weight will be displayed after *CAL.P0* is shown.
2. Remove all weight from the scale. Press the **TARE/PRESET** key to confirm and calibrate the zero point.
The zero weight will flash. After calculating the reasonable zero-point data, the zero weight will become steady.
When the first default standard weight is displayed after *CAL.P1* is shown, it will be calibrated on standard weight for the first point.
3. Place the corresponding weight (more than 10%FS weight) onto the scale.
The default standard weight is 100%FS.
4. Use the \uparrow \downarrow \leftarrow keys to enter the value of the loaded weight. Before entering this value, you can press and hold the **UNIT/DATA** key to change the unit of measure to kg or lb.
5. Press the **TARE/PRESET** key to confirm the entry.
The indicator will flash the input standard weight. When this weight number becomes steady, it means the stable and reasonable data corresponding to the standard weight has been received. After this, the indicator will automatically continue to the next step. If this point cannot be calibrated correctly (E.g. the weight load on the scale is too small, the input data is incorrect), it will display *CAL.Er* and return to step 2 for recalibration.
6. When *End.y* is shown and *y* is flashing, enter a command to exit calibration or go on to the next calibration.
7. Use the \uparrow \downarrow \leftarrow key to select yes or no. Use the **TARE/PRESET** key to confirm.
If yes is selected, you will be directed go to step8 to end calibration.
If no is selected, continue to the next step.
8. When 100%FS weight is displayed after *CAL.P2* is shown. This is the standard weight calibration for the second point. Place corresponding weight (more than 10%FS weight, and larger than the weight used on *CAL.P1*) onto the scale.
9. When *End.y* is shown and *y* is flashing, use the \uparrow \downarrow \leftarrow key to select yes or no. Use the **TARE/PRESET** key to confirm.
10. When the third standard weight displayed after *CAL.P3* is shown. This is the standard weight calibration for the third point. Place corresponding weight (more than 10%FS weight, and larger than the weight used on *CAL.P2*) onto the scale.

11. When the stable and reasonable data corresponding to the standard weight has been received, the indicator will automatically go to Step8. Otherwise, it will display *ERR* and return to the previous steps.

5.4 Geographical Adjustment

1. When *Geo* is selected, press the **TARE/PRESET** key to enter Geographical Adjustment.
2. When *Code* is displayed, press the \uparrow \downarrow \leftarrow key to select geographical position code or input user local gravity value directly.
3. When *Code* is selected, select the position code of the scale being used (00-70) according to the elevation and latitude from [Table 5.1](#) by using the \uparrow \downarrow \leftarrow key.
4. Press **TARE/PRESET** key to confirm.



CAUTION! Only an authorized manufacturer representative or certified verification personnel may make these changes. Changing the Geographical setting alters the calibration values!

Table 5.1 Location Code For Elevation and Latitude

Elevation (km)	0	0.2	0.4	0.6	0.8	1	1.2	1.4	1.6	1.8	2	2.2	2.4	2.6	2.8	3	3.2	3.4	3.6	3.8	4	4.2	4.4	4.6	4.8	5	5.2	5.4	5.6	5.8	6
Latitude	19	18	17	17	16	15	15	14	14	13	12	12	11	11	10	9	9	8	8	7	6	6	5	4	4	4	3	2	1	1	0
3	19	18	17	17	16	16	15	14	14	13	12	12	11	11	10	9	9	8	8	7	6	6	5	4	4	3	2	1	1	0	
6	19	18	18	17	17	16	15	15	14	14	13	12	12	11	10	10	9	9	8	7	7	6	6	5	4	4	3	2	2	1	1
9	20	19	19	18	17	17	16	15	15	14	14	13	12	12	11	11	10	9	9	8	7	7	6	6	5	4	4	3	2	2	1
12	21	20	20	19	18	17	16	16	16	15	15	14	13	13	12	11	11	10	10	9	8	8	7	7	6	5	4	3	3	2	2
15	22	21	21	20	20	19	18	18	17	16	16	15	15	14	13	13	12	11	11	10	10	9	8	8	7	6	5	4	3	3	2
18	23	23	22	22	21	20	20	19	19	18	17	17	16	15	15	14	13	12	11	11	10	10	9	8	7	6	5	4	3	3	2
21	25	25	24	23	23	22	21	21	20	20	19	18	18	17	16	16	15	15	14	13	13	12	11	10	10	9	8	7	6	5	4
24	27	26	26	25	25	24	23	23	22	21	21	20	20	19	18	18	17	17	16	15	15	14	13	13	12	11	10	10	9	8	7
27	29	29	28	27	27	26	25	25	24	24	23	22	22	21	21	20	19	19	18	17	17	16	16	15	14	14	13	12	12	11	11
30	31	31	30	30	29	28	28	27	26	26	25	25	24	23	23	22	22	21	20	20	19	18	18	17	17	16	15	14	14	13	13
33	34	33	33	32	31	31	30	30	29	28	28	27	26	26	25	25	24	23	23	22	21	21	20	20	20	19	18	17	17	16	15
36	36	36	35	34	34	33	33	32	31	31	30	30	29	28	28	27	26	26	25	25	24	23	23	22	22	21	20	20	19	18	18
39	39	38	38	37	36	36	35	35	34	33	33	32	32	31	30	30	29	28	28	27	27	26	25	25	24	24	23	22	22	21	20
42	42	41	40	40	39	39	38	37	37	36	35	35	34	34	33	32	32	31	31	30	29	29	28	27	27	26	26	25	24	24	23
45	44	44	43	42	42	41	41	40	39	39	38	38	37	36	36	35	34	34	33	33	32	31	31	30	30	29	28	28	27	26	26
48	47	46	46	45	45	44	44	43	42	41	41	40	40	39	38	38	37	37	36	35	35	34	33	33	32	32	31	30	30	29	29
51	50	49	48	48	47	47	46	45	45	44	44	43	42	42	41	40	40	39	39	38	37	37	36	36	35	34	34	33	32	32	31
54	52	52	51	50	50	49	49	48	47	47	46	46	45	44	44	43	42	42	41	41	40	39	39	38	38	37	36	36	35	34	34
57	55	54	54	53	52	52	51	51	50	49	49	48	47	47	46	46	45	44	44	43	43	42	41	41	40	39	39	38	38	37	36
60	57	57	56	55	55	54	54	53	52	52	51	51	50	49	49	48	47	47	46	46	45	44	44	43	43	42	41	41	40	39	39
63	60	59	58	58	57	56	56	55	55	54	53	53	52	52	51	50	50	49	48	48	47	47	46	45	45	44	44	43	42	42	41
66	62	61	60	60	59	59	58	57	57	56	56	55	54	54	53	52	52	51	51	50	49	49	48	47	47	46	46	45	44	44	43
69	64	63	62	62	61	61	60	59	59	58	57	57	56	56	55	54	54	53	53	52	51	51	50	49	49	48	48	47	46	46	45
72	65	65	64	63	63	62	62	61	60	60	59	59	58	57	57	56	55	55	54	54	53	52	52	51	51	50	49	49	48	47	47
75	67	66	66	65	64	64	63	62	62	61	61	60	59	59	58	58	57	56	56	55	54	54	53	53	52	51	51	50	50	49	48
78	68	67	67	66	66	65	64	64	63	62	62	61	61	60	59	59	58	58	57	56	55	54	54	53	53	52	51	51	50	50	49
81	69	68	68	67	67	66	65	65	64	63	63	62	61	60	60	59	59	58	58	57	56	55	54	54	53	53	52	51	51	50	50
84	70	69	68	68	67	67	66	65	65	64	64	63	62	62	61	60	60	59	59	58	57	57	56	56	55	54	54	53	52	52	51
87	70	70	69	68	68	67	66	66	65	65	64	63	63	62	62	61	60	60	59	59	58	58	57	56	56	55	54	54	53	52	52
90	70	70	69	68	68	67	67	66	65	65	64	64	63	62	62	61	60	60	59	59	58	58	57	56	56	55	54	54	53	52	52

5.5 Input or View Calibration

1. When *INPUT* is selected, press the **TARE/PRESET** key to enter Input calibration parameter values that were previously received or view current calibration parameter values.

All parameters regarding calibration are divided to 12 pages and are displayed on LCD by "nn:xxxx" format ("nn" is a decimal number of page, "xxxx" is an hexadecimal value of parameter. (e.g. 02:85E2).

01-02 pages: zero code

03-04 pages: standard weight of *CAL.P 1*

05-06 pages: codes of *CAL.P 1*

07-08 pages: standard weight of *CAL.P 2*

09-10 pages: codes of *CAL.P 2*

11-12 pages: full capacity net code

13-14 pages: the coefficient of weight fine-tune

15-16 pages: gravity value of calibration location

17-18 pages: gravity value of the location the scale is used at

2. When no digits are blinking on the display, this means calibration parameters value are being viewed. Use the **UNIT/DATA** key to view the next page. Use the **SETUP** key to return to the last sub-menu or use the **ZERO/ON/OFF** key to exit.
3. When parameter values are being viewed, press the **UNIT/DATA** key to modify.
4. When first digit is blinking, this means the value is being modified. Press the **UNIT/DATA** key to make next digit flash (if current flashing position is the last one the next page value will be shown).
5. Press the \uparrow \downarrow \leftarrow key to input the number.
6. Press the **TARE/PRESET** key to confirm.
7. press and hold the **PRINT/FUNC** key more than 4 seconds, for these parameters to be sent out. The print out format is <LF>nn:xxxx<CR>; there are a total of eighteen lines.
- 8.
9. After the indicator gets all needed data, it will calculate and store all calibration parameters into EEPROM or after finishing calibration, it will display *CAL.D*.
10. The scale will re-start and go back to original mode.

5.6 Display ADC Output Code

In this mode, you can examine the stability of weighing system and increment the ADC output code corresponding to the loaded weight. Please note the following:

- The increment of ADC code for full scale weight must be larger or equal to 10 times of selected display division. Otherwise, the calibration cannot be properly completed.
 - e.g. The display division is 0.1kg. Load 100kg standard weight on the platform, the increment of ADC code should be at least more than $10 \times 100\text{kg} / 0.1\text{kg} = 10 \times 1000 = 10000$. In this case, the scale can be calibrated. Otherwise, a smaller division needs to be chosen.
 - The variation of the ADC code should be small. Otherwise, the calibration cannot be properly completed.
1. From the weigh mode press the **SETUP** key until [OFF] is displayed.
 2. Use the \uparrow \downarrow \leftarrow key to go to [NET] .
 3. Press the **TARE/PRESET** key to enter this mode and display the ADC output raw code.
 4. Press the **TARE/PRESET** key to set the current code as a reference zero and then display net code
 5. Press **TARE/PRESET** again to clear this reference and display gross code.
 6. In display net mode, press the **UNIT/DATA** key to select displaying code that has been filtered by no-filter, filter1 and filter2. The LO, OK, and HI annunciators will be lit.
 7. Press the **SETUP** key to return to the last menu item.
 8. Press the **[ON/OFF]** key to exit this mode.

6 Serial Communication

6.1 Communication Details

1. COM1 is RS232, communication wires come from RS232 connector, and TXD0, RXD0 and GND are used. Please refer to section 9 for connector details
2. COM2 is USB used as a virtual RS232, communication wires come from USB connector, and TXD1, RXD1 and GND are used, Please refer to section 9 for connector details.
3. The baud rate and byte format is set by USER-COM1/2-BAUD.RT and USER-COM1/2-BYT.FMT. Responses to serial commands will be immediate, or within one weight measure cycle of the scale. One second should be adequate for use as a time-out value by remote (controlling) device.

6.2 Transaction String

The length of each item in a transaction string:

- Reading data --- 6 bytes
- Data polarity ----1 byte: "-" for negative, and followed the first digit; " " for positive.
- Decimal point ---1 byte: "."
- Measure unit ----1-5 bytes:" lb", " kg", "lb:oz", "pcs", "%". Units are always lower case, left aligned
- Current status-- 4 bytes
 - If the weight is over capacity, the scale will return eight "^" characters (the field of polarity, decimal point, weight data is filled by "^").
 - If the weight is under capacity, it will return eight "_" characters (the field of polarity, decimal point, and weight data is filled by "_").
 - If the zero point is error, it will return eight "-" characters (the field of polarity, decimal point, and weight data is filled by "-").

Useless leading 0 before digits is suppressed. Reading weight is right aligned.

Table 6.1 Symbols Used

<LF>	Line Feed character (hex 0AH)
<CR>	Carriage Return character (hex 0DH)
<ETX>	End of Text character (hex 03H)
<SP>	Space (hex 20H)
H ₁ H ₂ H ₃ H ₄	Four current status bytes
<P>	Polarity character: "-" or " "

W₁---W₆	Reading data, 1-6 bytes (six digits)
<DP>	Decimal point
U₁U₂ U₃U₄U₅	Measure units, kg, lb, lb:oz, % or pcs; 2-5 bytes
<Add>	Address of scale; 2 bytes (00-99)
<Prompt>	Prompt characters of output content; max. 11bytes

Table 6.2 Bit Definition of H₁H₂H₃ H₄

Bit	Byte 1 (H ₁)	Byte 2 (H ₂)	Byte 3 (H ₃)	Byte 4 (H ₄)
0	0 = stable	0 = not under capacity	00 = compare disable 01 = lower limit 10 = ok 11= upper limit	00 = normal weighing 01 = count weighing 10 = percent weighing 11 = other mode
	1 = not stable	1 = under capacity		
1	0 = not at zero point	0 = not over capacity		
	1 = at zero point	1 = over capacity		
2	0 = RAM ok	0 = ROM ok	0 = gross weight	0 = not in HOLD
	1 = RAM error	1 = ROM error	1 = net weight	1 = in HOLD
3	0 = eeprom OK	0 = calibration ok	0 = initial zero ok	0 = battery ok
	1 = eeprom error	1 =calibration error	1 = initial zero error	1 = low battery
4	always 1	always 1	always 1	always 1
5	always 1	always 1	always 1	always 1
6	always 0	always 1	always 1	always 0
7	parity	Parity	parity	Parity

6.3 Commands and Response

6.3.1 User - Com 1/2 Layout

Set to *SINGLE*

Command: W<CR> (57h 0dh), request current reading

Response
<LF>^^^^^^U ₁ U ₂ U ₃ U ₄ U ₅ <CR><LF> H ₁ H ₂ H ₃ H ₄ <CR><ETX>---over capacity
<LF>_____ U ₁ U ₂ U ₃ U ₄ U ₅ <CR><LF> H ₁ H ₂ H ₃ H ₄ <CR><ETX>---under capacity
<LF>----- U ₁ U ₂ U ₃ U ₄ U ₅ <CR><LF> H ₁ H ₂ H ₃ H ₄ <CR><ETX>---zero-point error
Note: U ₁ U ₂ U ₃ U ₄ U ₅ is 1,2,3 or 5 bytes according to current unit: %, kg, lb, pcs, lb:oz
<LF><P>W ₁ W ₂ W ₃ W ₄ W ₅ <DP>W ₆ U ₁ U ₂ U ₃ U ₄ U ₅ <CR><LF> H ₁ H ₂ H ₃ H ₄ <CR><ETX>---normal data
Note: (1) The decimal point position is determined by CONFIG-PRIM.D (2) If current unit is "lb:oz", the format will be similar with following:
<LF><P>W ₁ W ₂ W ₃ lb <SP>W ₄ W ₅ <DP>W ₆ oz <CR><LF> H ₁ H ₂ H ₃ H ₄ <CR><ETX>

Command: S<CR> (53h 0dh), request current status

Response
<LF> H ₁ H ₂ H ₃ H ₄ <CR><ETX>

Command: Z<CR> (5ah 0dh)

Response
Zero function is activated (simulate ZERO key) and it returns to current scale status.
<LF> H ₁ H ₂ H ₃ H ₄ <CR><ETX>
If ZERO function cannot be activated, it will return to current scale status.

Command: T<CR> (54h 0dh)

Response
TARE function is activated (simulate TARE key), and then returns scale status.
<LF> H ₁ H ₂ H ₃ H ₄ <CR><ETX>
If TARE function cannot be activated, it will return to current scale status.

Command: U<CR> (55h 0dh)

Response
Changes units of measure (simulate UNIT key) and return scale status with new units. The new measure unit should be allowed to use
<LF> U ₁ U ₂ U ₃ U ₄ U ₅ <CR><LF> H ₁ H ₂ H ₃ H ₄ <CR><ETX>

Command: L<CR> (4ch 0dh)

Response
If Hold function can be activated, it will enable/disable hold function (simulate HOLD key) and returns scale status.
<LF> H ₁ H ₂ H ₃ H ₄ <CR><ETX>

Command: X<CR> (58h 0dh)

Response
Power off the scale. Same as pressing the ON/OFF key to turn off the scale.

Command: all others

Response
Unrecognized command
<LF>? <CR><ETX>

Table 6.3 Summary of Command and Response:

Command		Response
ASCII	HEX	
W<CR>	57 0d	Read scale weight: <LF>^^^^^^U ₁ U ₂ U ₃ U ₄ U ₅ <CR><LF> H ₁ H ₂ H ₃ H ₄ <CR><ETX>---over capacity <LF>_____U ₁ U ₂ U ₃ U ₄ U ₅ <CR><LF> H ₁ H ₂ H ₃ H ₄ <CR><ETX>---under capacity <LF>----- U ₁ U ₂ U ₃ U ₄ U ₅ <CR><LF> H ₁ H ₂ H ₃ H ₄ <CR><ETX>---zero-point error <LF><P>W ₁ W ₂ W ₃ W ₄ W ₅ <DP>W ₆ U ₁ U ₂ U ₃ U ₄ U ₅ <CR><LF>H ₁ H ₂ H ₃ H ₄ <CR><ETX>---normal data
S<CR>	53 0d	<LF>H ₁ H ₂ H ₃ H ₄ <CR><ETX>; read scale status
Z<CR>	5a 0d	<LF>H ₁ H ₂ H ₃ H ₄ <CR><ETX>; simulate ZERO key

Command		Response
ASCII	HEX	
T<CR>	54 0d	<LF>H ₁ H ₂ H ₃ H ₄ <CR><ETX>; simulate TARE key
U<CR>	55 0d	<LF> U ₁ U ₂ U ₃ U ₄ U ₅ <CR><LF>H ₁ H ₂ H ₃ H ₄ <CR><ETX>; simulate UNIT key
L<CR>	4c 0d	<LF>H ₁ H ₂ H ₃ H ₄ <CR><ETX>; simulate HOLD key
X<CR>	58 0d	power off the scale, simulate OFF key
others		<LF>? <CR><ETX>

6.3.2 Parameter Multi

Set the USER-COM1/2-LAYOUT parameter to $\bar{n}U\bar{L}PL$.

Output string frame
Command: W<CR> (57h 0dh), request current reading
<LF><Prompt><p>W ₁ W ₂ W ₃ W ₄ W ₅ <DP>W ₆ U ₁ U ₂ U ₃ U ₄ U ₅ <CR>
Line number and content are determined by setting of USER-OUT1/2-xxxx
<LF><Prompt>H ₁ H ₂ H ₃ H ₄ <CR>
USER-OUT-STATUS is set to YES
<LF>
(1) The decimal point position is determined by CONFIG-PRIM.D (2) The unit position and bytes are determined by which current unit is used (3) The details of <Prompt> refer to the content in User submenu (4) In HOLD mode, if ADC conversion speed is set to high speed (80Hz) and USER-COM-LAYOUT is set to MULTI, the output from COM may be slower than the data processed by the indicator. For "real time" data, select fewer output contents and set a higher baud rate for C<CR> --- USER-OUT-LINE is set to LINE1/2/3/4
Line number and content are determined by setting of USER-OUT1/2-xxxx
<ETX>
--- Last byte of string frame

Example Layouts

When USER-OUT1/2-xxxx is set to YES

Weighing Mode:

SCALE ID:	123456
GROSS:	123lb 4.56oz
TARE:	11lb 2.22oz
NET:	112lb 2.34oz
ACC.N	8
TOTAL	789lb 15.2oz
DATE	2014-12-29
TIME	12:34:56
A/D CODE:	1234567
VOLTAGE:	6.7V
STATUS:	bpq2

Counting Mode:

SCALE ID:	123456
GROSS:	1234.55kg
TARE:	12.15kg
NET:	1222.40kg
QUANTITY:	24448pcs
PIECE WT:	0.05kg
ACC.N	10
TOTAL	23456pcs
DATE	2014-12-29
TIME	12:34:56
A/D CODE:	1234345
VOLTAGE:	6.7V
STATUS:	bpq2

In Percent Weighing Mode:

SCALE ID:	123456
GROSS:	12345lb
TARE:	10lb
NET:	12335lb
PERCENTAGE:	91.4%
1% REF. WT.	135lb
ACC.N	3
TOTAL	271.6%

DATE 2014-12-29
 TIME 12:34:56
 A/D CODE: 1234345
 VOLTAGE: 6.7V
 STATUS: bpq2

In BMI Mode

SCALE ID: 123456
 GROSS: 110.0kg
 TARE: 10.0kg
 NET: 100.0kg
 HEIGHT 170cm
 BMI 34.6
 DATE 2014-12-29
 TIME 12:34:56
 A/D CODE: 1234567
 VOLTAGE: 6.7V
 STATUS: bpq2

6.3.3 Parameter EH-S (PS-60)

Set the USER-COM1/2-LAYOUT parameter to $EH-SP$ (EH-SP1)

This protocol is compatible with Toledo PS60 protocol. The baud rate and data format is set by User menu.

Output Status Bit Meaning

Table 6.4 Status Bits

Bit	Status
0	0 = not in motion
	1 = in motion
1	0 = not over capacity
	1 = over capacity
2	0 = not under zero (positive polarity)
	1 = under zero (negative polarity)
3	0 = inside zero capture range
	1 = outside zero capture range
4	0 = not center of zero
	1 = center of zero
5	always 1
6	always 1
7	parity

Summary of Command and Response

Command		Response
ASCII	HEX	
W	57	Read scale weight: <STX>W ₁ W ₂ <DP>W ₃ W ₄ W ₅ <CR>---normal data <STX>? [<Status Byte>]<CR>--if current weight is invalid
Z	5a	Simulate ZERO key: <STX>? [<Status Byte>]<CR>
L	4c	Switch to and send standard weight. Same as W above
K	4b	Switch to and send metric weight. Same as W above
others		Unknown commands: <STX>? [<Status Byte>]<CR>

Set the USER-COM1/2-LAYOUT parameter to eh-sp2

This protocol is compatible with Toledo PS60 UPS protocol. The baud rate and data format is set by User menu.

Output Status Bit Meaning:

MM	Status Byte
gg	Scale in motion
GG	Stable weight data

Summary of Command and Response

Command		Response
ASCII	HEX	
<CR>	0d	Read scale weight: <P>W ₁ W ₂ W ₃ <dp>W ₃ W ₄ <sp>U ₁ U ₂ <sp>MM<sp><sp><CR><LF><ETX>

6.3.4 Parameter SCP-12 (NCI3835)

Set the USER-COM1/2-LYOUT parameter to *SCP-12*.

This protocol of serial communication is similar to the NCI3835 protocol. The baud rate and data format is set by User menu.

Output Status Bit Meaning

Bit	Byte 1	Byte 2
0	0 = not stable	0 = not under capacity
	1 = stable	1 = under capacity
1	0 = at zero point	0 = not over capacity
	1 = not at zero point	1 = over capacity
2	0 = RAM error	0 = ROM ok
	1 = RAM ok	1 = ROM error
3	0 = eeprom error	0 = calibration ok
	1 = eeprom ok	1 = calibration error
4	always 1	always 1
5	always 1	always 1
6	always 0	always 0
7	parity	parity

Table 6.5 Symbols Used

<LF>	Line Feed character (hex 0A)
<CR>	Carriage Return character (hex 0D)
<ETX>	End of Text character (hex 03)
xxxxxx	Weight characters from display including minus sign a out of range characters
hh	Two status bytes
p	Polarity character: "-" for negative or " " for positive
UU	Units of measure (LB, KG, OZ all upper case)

Table 6.6 Summary of Command and Response:

Command		Response
ASCII	HEX	
W<CR>	57 0d	Returns decimal lb, kg or oz weight, units and status. <LF>pxxx.xxUU<CR>hh<ETX> Returns ounces weight with units plus scale status. <LF>p00xxxxxOZ<CR>hh<ETX> Scale status only if initial zero error. <LF>hh<CR><ETX>
S<CR>	53 0d	<LF>HH<CR><ETX>: read scale status
Z<CR>	5a 0d	Simulate ZERO key. No response from scale
others		Unknown commands: <LF>? <CR>

6.4 Output Print Formats

Table 6.7 Output Data Strings

Formatted Output Data String					Selection Display
<LF>	WWW.WW	uu	<CR>	<LF>	LFuuLF*
<LF>	WWW.WW	uu	<CR>		LFuu-
<LF>	WWW.WW		<CR>	<LF>	LF-LF
<LF>	WWW.WW		<CR>		LF--
	WWW.WW	uu	<CR>	<LF>	-uuLF
	WWW.WW	uu	<CR>		-uu-
	WWW.WW		<CR>	<LF>	--LF
	WWW.WW		<CR>		---

*Default factory setting

Table 6.8 Symbols Used

<LF>	Line Feed character (hex 0A)
W	Weight characters from display
u	Units of measure
<CR>	Carriage Return character (hex 0D)

6.5 UPS Worldship

Try the following settings:

- (1) USER-COM1(or 2)-BAUD.RT=4800
- (2) USER-COM1(or 2)-BYT.FMT=7E1
- (3) USER-COM1(or 2)-LAYOUT=SCP-12
- (4) Set scale port to NCI3835 in UPS worldship.

7 Test

7.1 Display Test

1. Press the **SETUP** key until `CONF, G` is displayed.
1. Use the `↑ ↓ ←` key to select `TEST-DSP, TEST` menu.
2. Press **TARE/PRESET** to enter the test display mode and all segments will light at first.
- 2a. In this mode, every press of the **ACC/TOTAL** key will light the next segment. Every press of the **UNIT/DATA** key will light the next digit.
- 2b. Press the **PRINT/FUNC** key to automatically light all segments and all digits.
3. Press the **SETUP** key to return to the last menu item.
4. Press the **ZERO/ON/OFF** key to exit.

7.2 Serial Port 1/2 (COM1/2) Receiving Test

Before testing the receiving function of COM1 or COM2, a cable is need to connect a computer to the scale. A terminal program such as Hyper Terminal is also needed for testing.

Note: baud rate is selected by USER-COM1/2-BAUD.RT, 8N1 byte format is fixed, Hex data (0x00 - 0x7f) are used.

1. Press and hold the **SETUP** key until `CONF, G` is displayed.
2. Use the `↑ ↓ ←` key to select `TEST-COM1, rd` or `TEST-COM2, rd` item.
3. Press **TARE/PRESET** to enter test COM1/2 receiving function. `rd 1, - -` or `rd 2, - -` will be displayed.

In this mode, received hex data (0x00 - 0x7f) will be displayed in `- -` position.

4. Press the **SETUP** key to return to last menu item.
5. Press the **ZERO/ON/OFF** key to exit.

7.3 Serial Port 1/2 (COM1/2) Transmitting Test

Before testing the receiving function of COM1 or COM2, a cable is need to connect a computer to the scale. A terminal program such as Hyper Terminal is also needed for testing.

Note: baud rate is selected by USER-COM1/2-BUD.RT, 8N1 byte format is fixed, Hex data (0x00 - 0x7f) are used.

1. Press and hold the **SETUP** key until `CONF, G` is displayed.

2. Use the \uparrow \downarrow \leftarrow key to select *TEST-COM1* or *TEST-COM2* item.
3. Press **TARE/PRESET** to enter test COM1/2 receiving function. *1--* or *2--* will be displayed.

In this mode, received hex data (0x00 - 0x7f) will be displayed in -- position.
4. Press the **SETUP** key to return to last menu item.
5. Press the **ZERO/ON/OFF** key to exit.

7.4 Keyboard and Buzzer Test





































1. Press and hold the **SETUP** key until *CONF, G* is displayed.
2. Use the \uparrow \downarrow \leftarrow key to select *TEST-KEY* item.
3. Press **TARE/PRESET** to enter test keypad mode.

KEY -- will be displayed
4. In this mode, press a key. The value of the key will be displayed and the buzzer will beep depending on what the USER-BEEP-KEY item is set to.
5. Press the **SETUP** key to return to last menu item.
6. Press the **ZERO/ON/OFF** key to exit.

8 Troubleshooting

This chapter gives explanations on commonly seen errors, display characters and display symbols.

8.1 Display Characters

ASCII	LCD/LED	ASCII	LCD/LED	ASCII	LCD/LED
0		A		N	
1		B		O	
2		C		P	
3		D		Q	
4		E		R	
5		F		S	
6		G		T	
7		H		U	
8		I		V	
9		J		W	
		K		X	
		L		Y	
		M		Z	

8.2 Display Symbols

Symbol	Description
<i>CAP. - - -</i>	Next displaying content is capacity
<i>CAL.P11</i>	Calibration on point (x)
<i>CAL.OFF</i>	Calibration seal switch is on OFF position
<i>CAL.ON</i>	Calibration seal switch is on ON position
<i>CAL.END</i>	End calibration
<i>Comp</i>	In Compare data mode
<i>PRETARE</i>	Preset TARE weight
<i>HIGH</i>	Input HIGH limitation data of Comparison
<i>LOW</i>	Input LOW limitation data of Comparison
<i>SPL.LO</i>	Sample load weight of low point.
<i>SPL.HI</i>	Sample load weight of high point.
<i>SPL.PWT</i>	Sample goods weight to calculate piece weight
<i>INPPCS</i>	Input number of pieces being counted
<i>SPL.PCT</i>	Input percentage weight
<i>ACC.IIIII</i>	Number of accumulations (xxx)

8.3 Error Messages and Troubleshooting

Symptom	Probable Cause	Remedy
Scale does not turn on	<ol style="list-style-type: none"> 1. AC adapter is not connected securely 2. Low battery 3. Indicator is damaged 	<ol style="list-style-type: none"> 1. Re-plug the AC adapter or rotate the plug to securely connect it to the scale 2. Replace the batteries 3. Replace with a new indicator and perform calibration
<i>Rd---</i> <i>Rd---</i>	<ol style="list-style-type: none"> 1. The cable from platform to indicator is not correctly connected, or disconnected, or short circuit 2. Indicator is damaged 3. Load cell cable is broken 4. Load cell is damaged 	<ol style="list-style-type: none"> 1. Replace a new indicator and perform calibration. 2. Return the scale for repair
<i>0----</i>	<ol style="list-style-type: none"> 1. Weight reading exceeds Power On Zero limit. 2. Display is out of zero range 	<ol style="list-style-type: none"> 1. Ensure scale platform is empty 2. Perform zero calibration. 3. Reduce the weight on the platform, until the indication is within the key zero range
<i>0-----</i>	Weight reading below Power On Zero limit.	<ol style="list-style-type: none"> 1. Install platform on scale. 2. Perform zero calibration. 3. Check whether an object stuck between the load cell and scale base, if yes, remove the object
<i>-----</i>	<ol style="list-style-type: none"> 1. Weight reading exceeds Overload limit. 2. The weight value cannot be displayed in the current unit of measure because it exceeds 6 digits. 	<ol style="list-style-type: none"> 1. Reduce load on scale until weight value can be displayed. 2. Use a more appropriate unit of measure.
<i>-----</i>	Weight reading below Under load limit.	<ol style="list-style-type: none"> 1. Install platform on scale. 2. Perform zero calibration.
<i>EEEE1</i>	CONFIG or CAL parameters are not correctly set.	<ol style="list-style-type: none"> 1. Re-set items in CONFIG 2. re-calibration.
<i>EEEE2</i>	USER parameter is not correctly set.	Re-set items in USER.
<i>CAL.Er</i>	Calibration error. Input data or loaded weight is too small, too big, unstable, non-linear.	<ol style="list-style-type: none"> 1. Input correct data, load correct weight onto platform. 2. Return for repair.
<i>Stb.Er</i>	When in HOLD mode, weighing object cannot become stable in 9 seconds, and the weight variation is more than 5d.	<ol style="list-style-type: none"> 1. Stabilize the object in short time. 2. Set a larger HOLD parameter "HLD-RNG"
Cannot zero the display	<ol style="list-style-type: none"> 1. Load on scale exceeds allowable limits.(2%FS) 2. Load on the scale is unstable 	<ol style="list-style-type: none"> 1. Remove load on scale. 2. Wait for load to become stable. then press the ZERO/ON/OFF key to zero the display.

Symptom	Probable Cause	Remedy
<i>P<small>U</small>E<small>R</small></i>	Piece weight is error, it's too small (<0.5d), The weight on the platform is too small to define a valid reference weight.	Use more weight for the sample.
1. Max. CAPACITY is not same as marked on overlay. 2. Any function invalid 3. Any measuring units missed.	CONFIG parameters are not correctly set	Reset CONFIG parameters.
Incorrect counting result or percent weighing result when using SPL to enter a piece weight or unit-percent weight	1. Sampling quantity is too small. 2. Calculated piece weight or unit-percent weight is a little different from the real value.	Increase the sampling quantity.
Weighing is not accurate	1. An object is stuck between the load cell and scale base. 2. Load cell received a heavy impact	1. Remove the object. 2. Perform Linearity calibration 3. Perform GEO calibration
Battery symbol is empty or <i>L<small>o</small>B<small>A</small>T<small>E</small></i> is shown	Low battery.	Replace the batteries.

8.4 Replacement Parts

Part Number	Description
	9V 600mA power adapter, center positive
	Display indicator



Brecknell USA

1000 Armstrong Dr.
Fairmont MN 56031
Tel:507-238-8702
Fax:507-238-8271
Email: sales@brecknellscales.com
<http://www.brecknellscales.com>

Brecknell UK

Foundry Lane,
Smethwick, West Midlands,
England B66 2LP
Tel:+44 (0) 8452 46 6717
Fax:+44 (0) 8452 46 6718
Email:
sales@brecknellscales.co.uk
<http://www.brecknellscales.com>